



Scientific Graphing and Analysis Software

Origin is on all Physics 403 computers.

What it can do:

1. Graphical presentation of data

2. Data analysis

3. Preparation of publication-quality figures

- Specially designed for scientific graphics
- “Standard” Windows application, does not require knowledge of C++ or any other high level computer language
- Can write special functions or procedures using Origin programming tools

Importing data

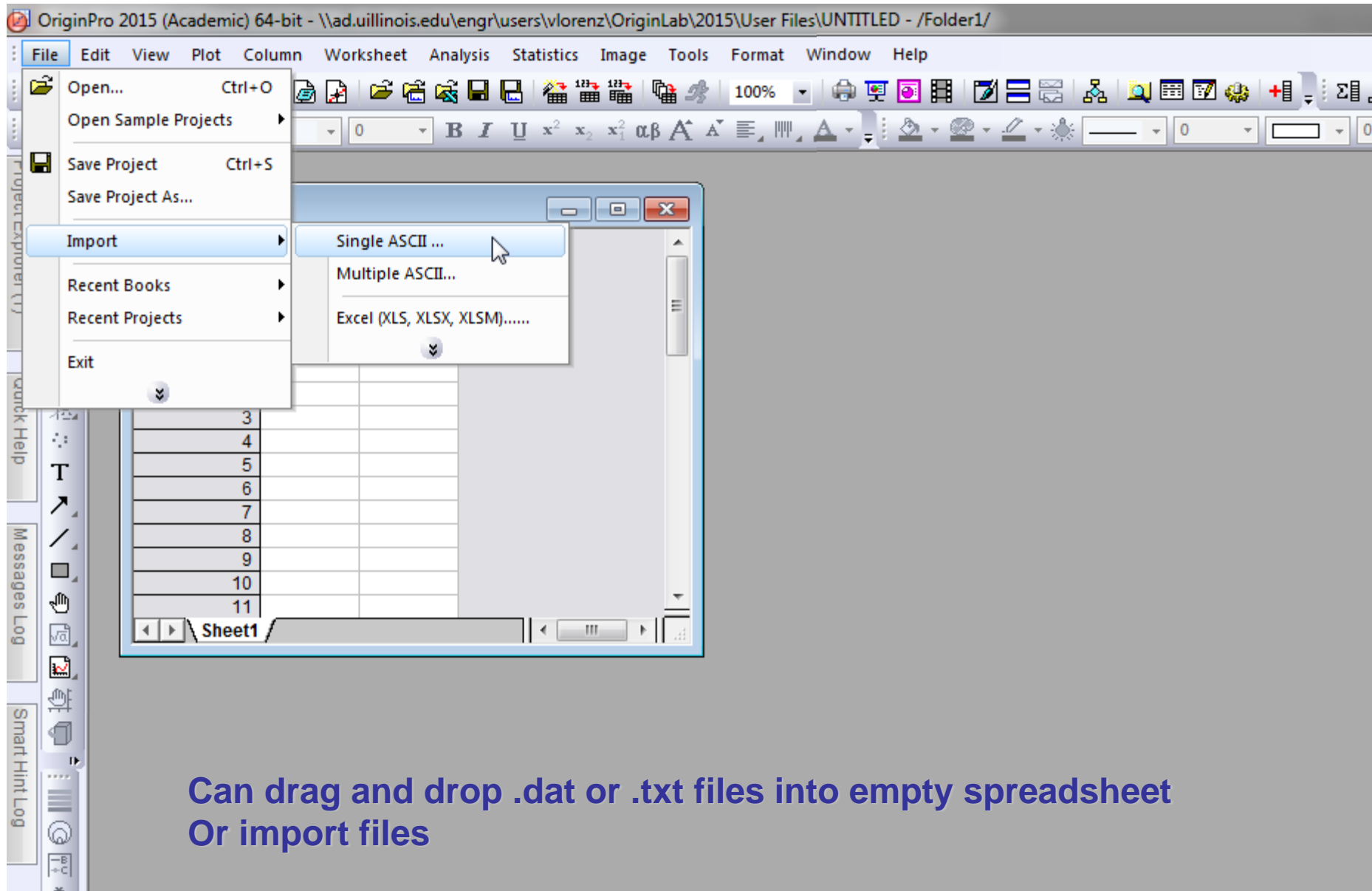

Can drag and drop .dat or .txt files into empty spreadsheet
Or import files

Graphical presentation of data: Basic Plot

The screenshot displays the OriginPro 2015 (Academic) 64-bit interface. The main window shows a data table with columns A(X) and B(Y). A plot menu is open, showing options for creating a line plot. The data table is as follows:

	A(X)	B(Y)
Long Name	Freq	Vrea
Units		
Comments		
F(x)=		
Sparklines		
1	20	0.00
2	21	-0.00
3	22	2.07
4	23	0.00
5	24	0.00
6	25	0.00
7	26	-2.88
8	27	0.01
9	28	0.00

The plot menu is open, showing the following options:

- Plot
- Copy
- Copy Columns to...
- Set As
- Set As Categorical
- Set Column Values... Ctrl+Q
- Sort Worksheet
- Hide/Unhide Columns
- Properties...

The 'Line' option is selected, and a sub-menu is open showing the following options:

- Line
- Symbol
- Line + Symbol
- Column/Bar/Pie
- Multi-Y
- Y-offset/Waterfall
- Multi-Panel
- Statistics
- Contour/Heat Map
- Profile
- Specialized
- 1 Line

Graphical presentation of data: Basic Plot

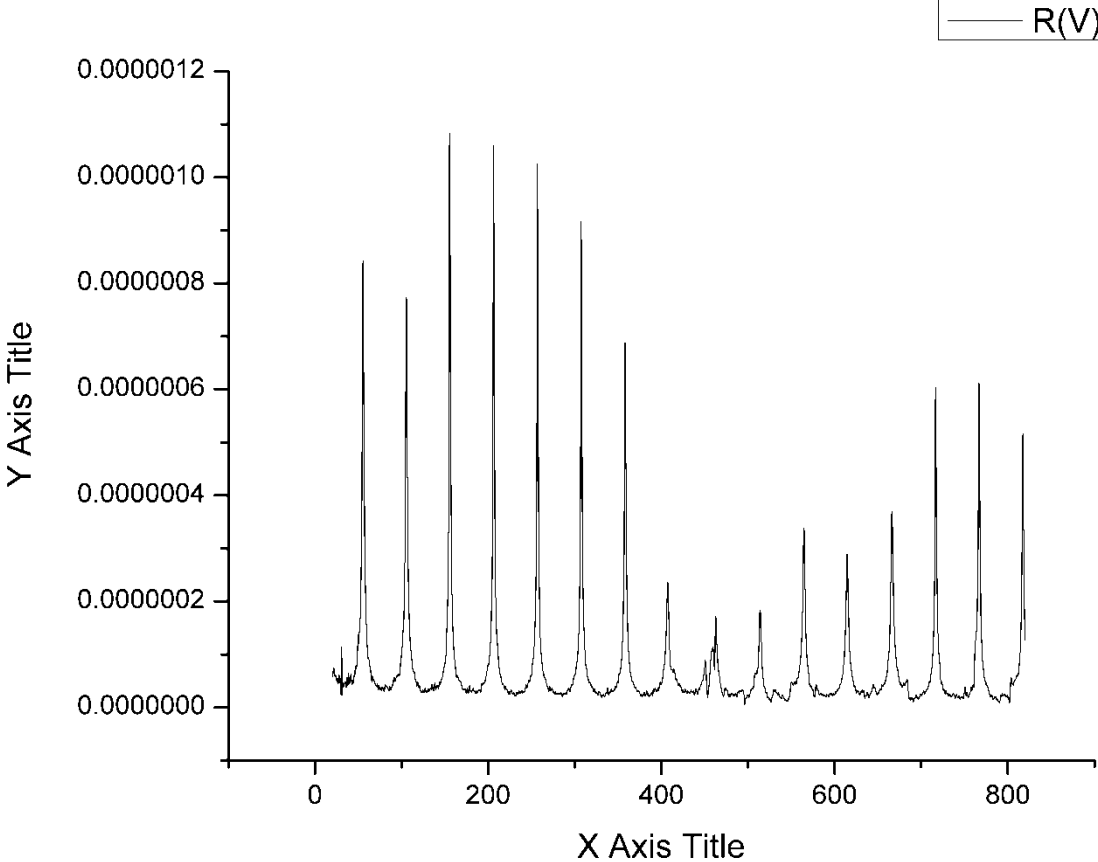

Graphical presentation of data: Basic Plot

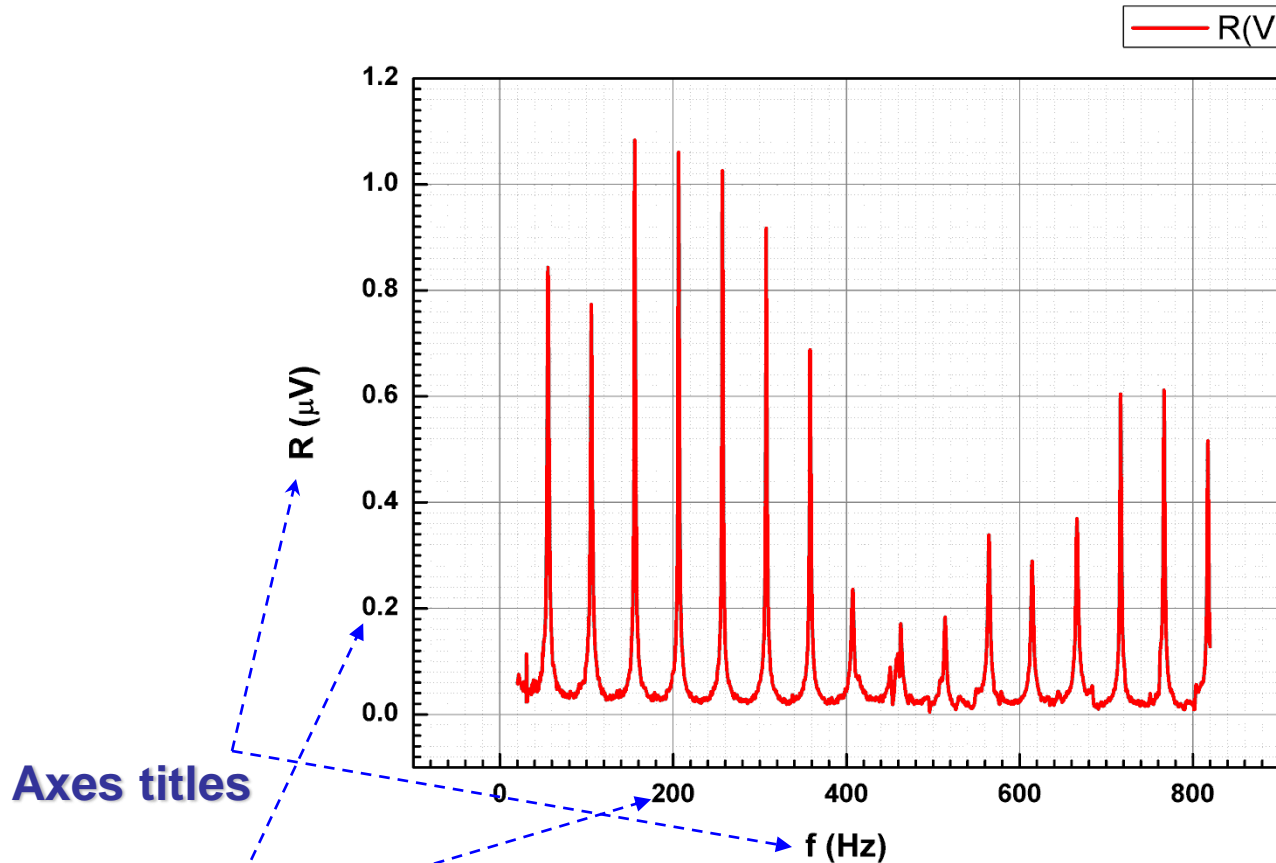

Top and Right axes,
grid lines

Axes titles

Bold tick labels.

For a better-looking graph, volts were converted to μV

Graphical presentation of data: Templates

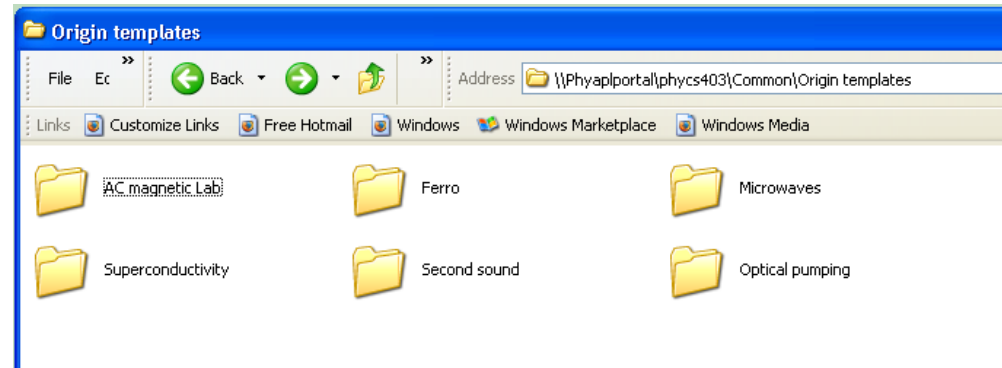
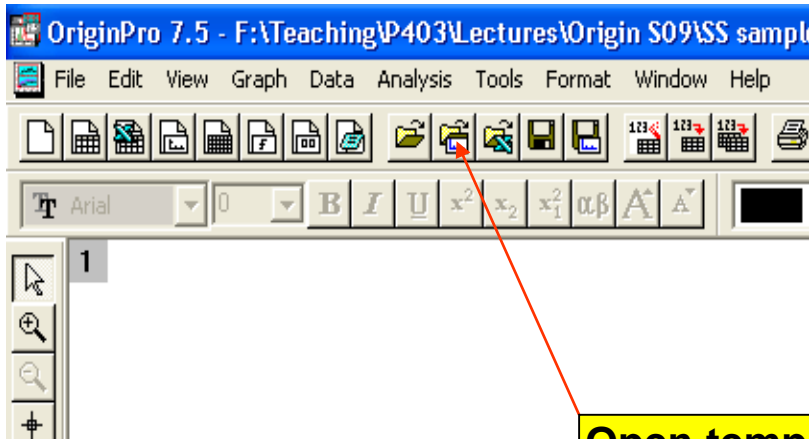

Open template

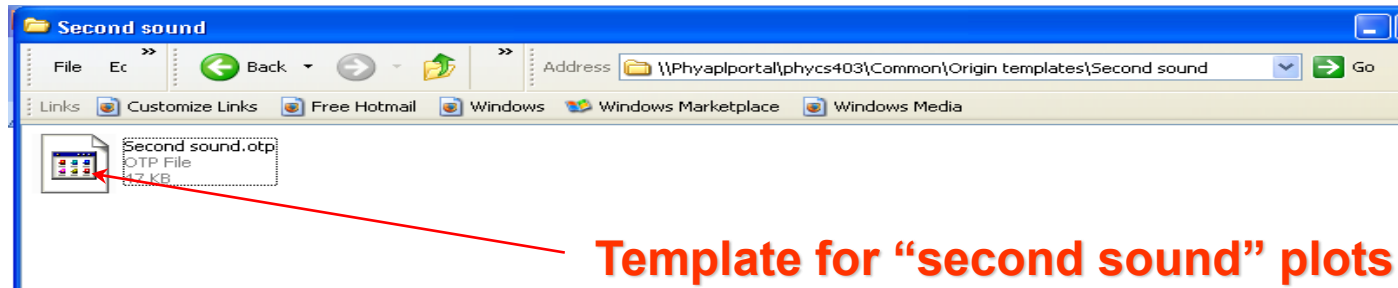

Template for "second sound" plots

Graphical presentation of data: Templates

Second sound data

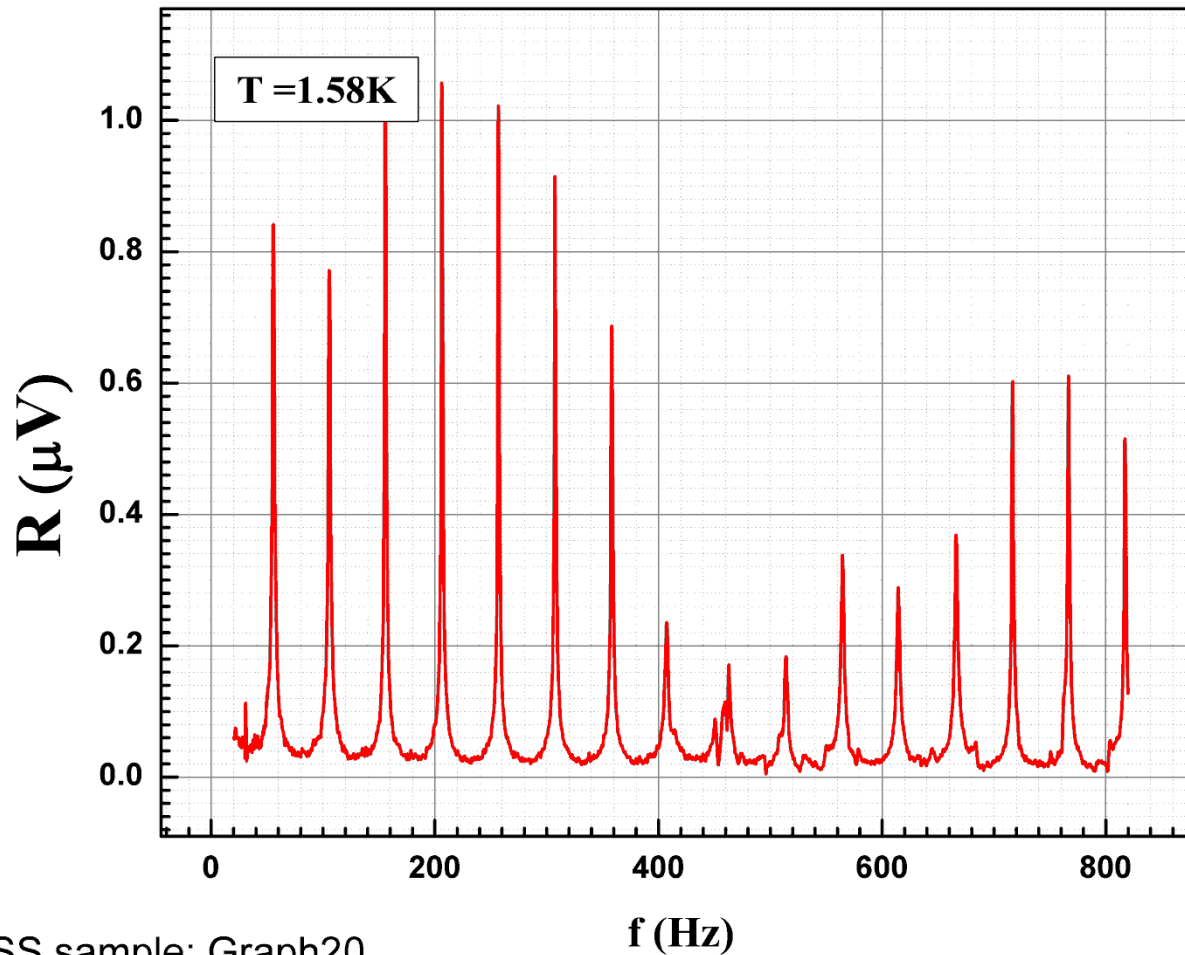

SS sample: Graph20

Graphical presentation of data: Fitting, etc.

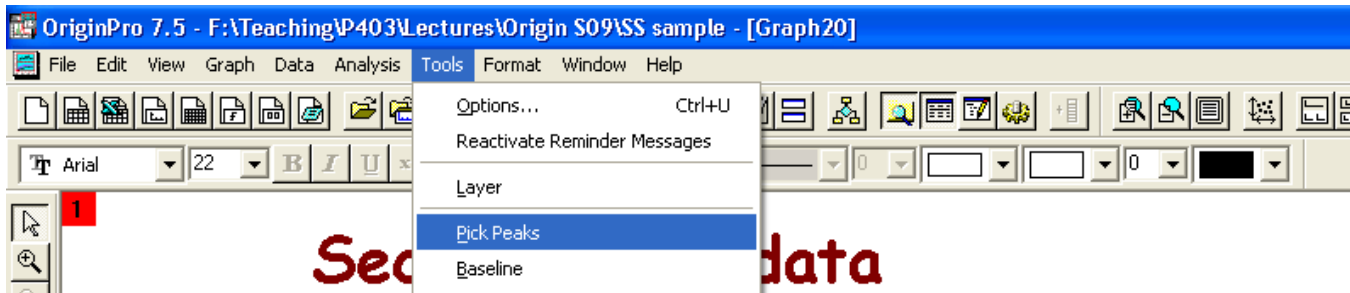

Second sound data

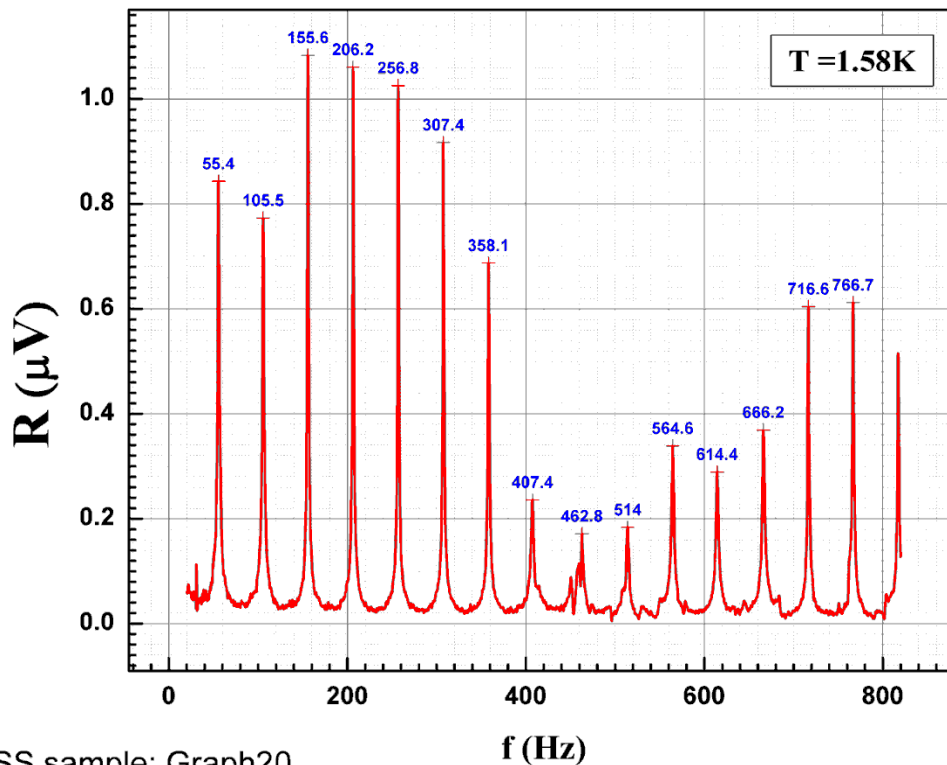

SS sample: Graph20

Second sound data

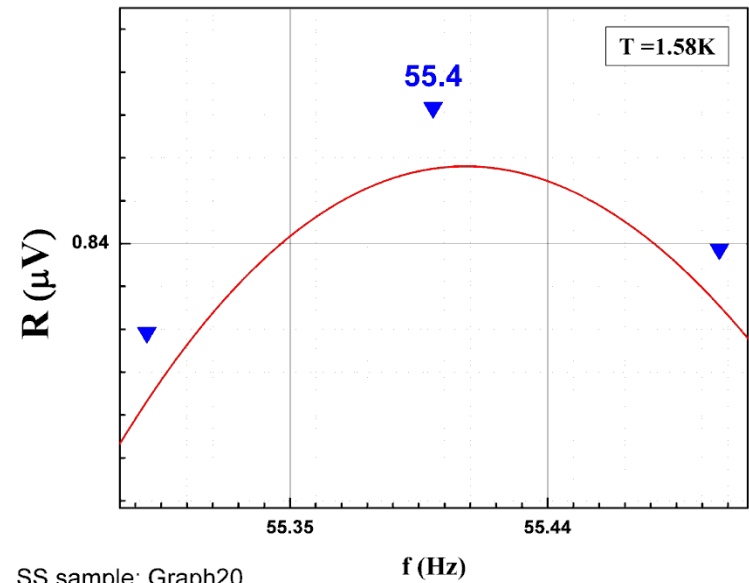

SS sample: Graph20

Graphical presentation of data: Fitting, etc.

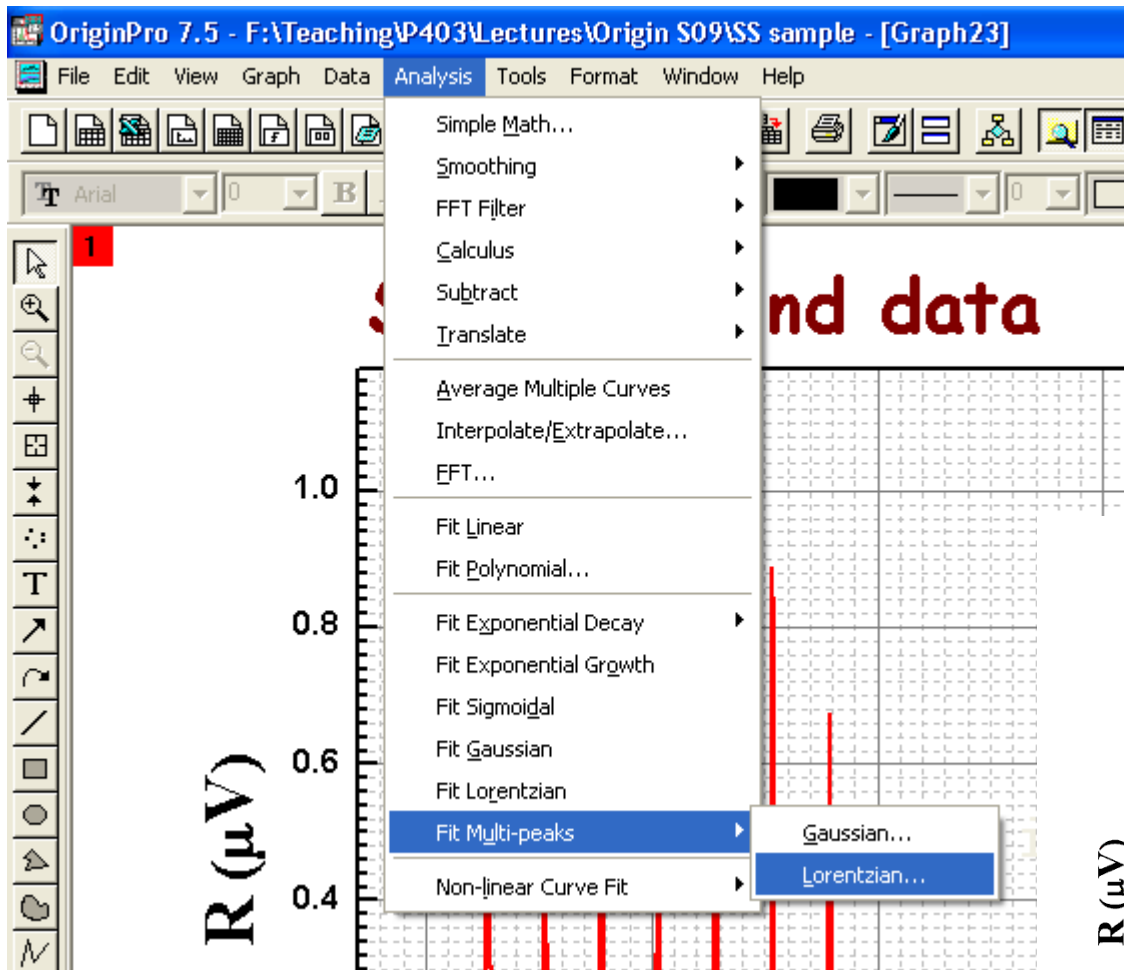

Second sound data

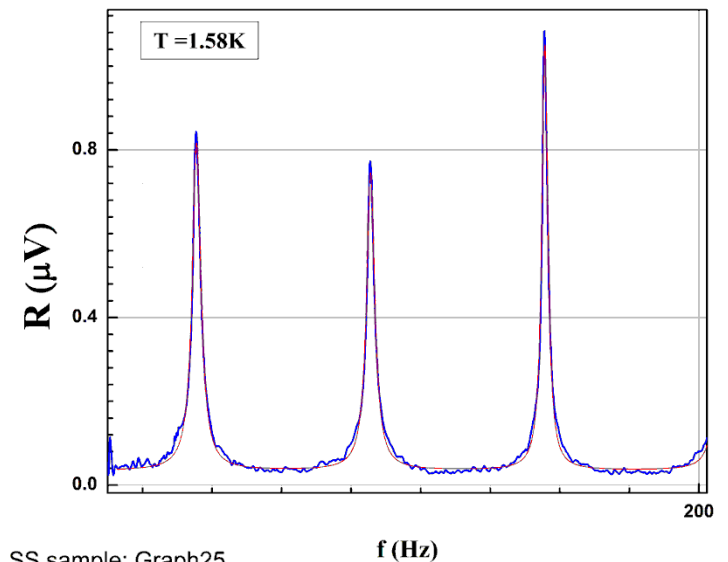

Graphical presentation of data: Fitting, etc.

Second sound data

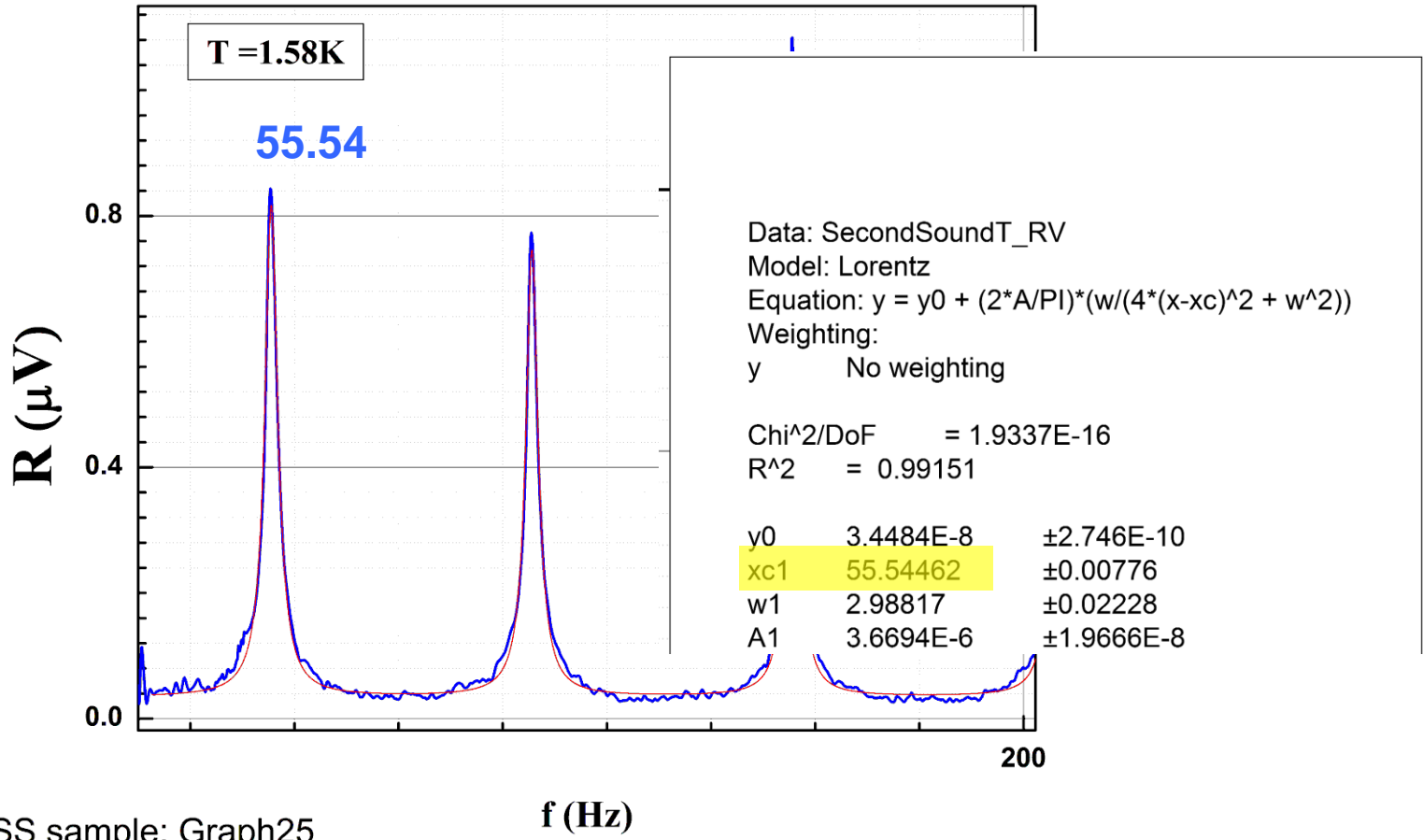

Graphical presentation of data: Fit Linear

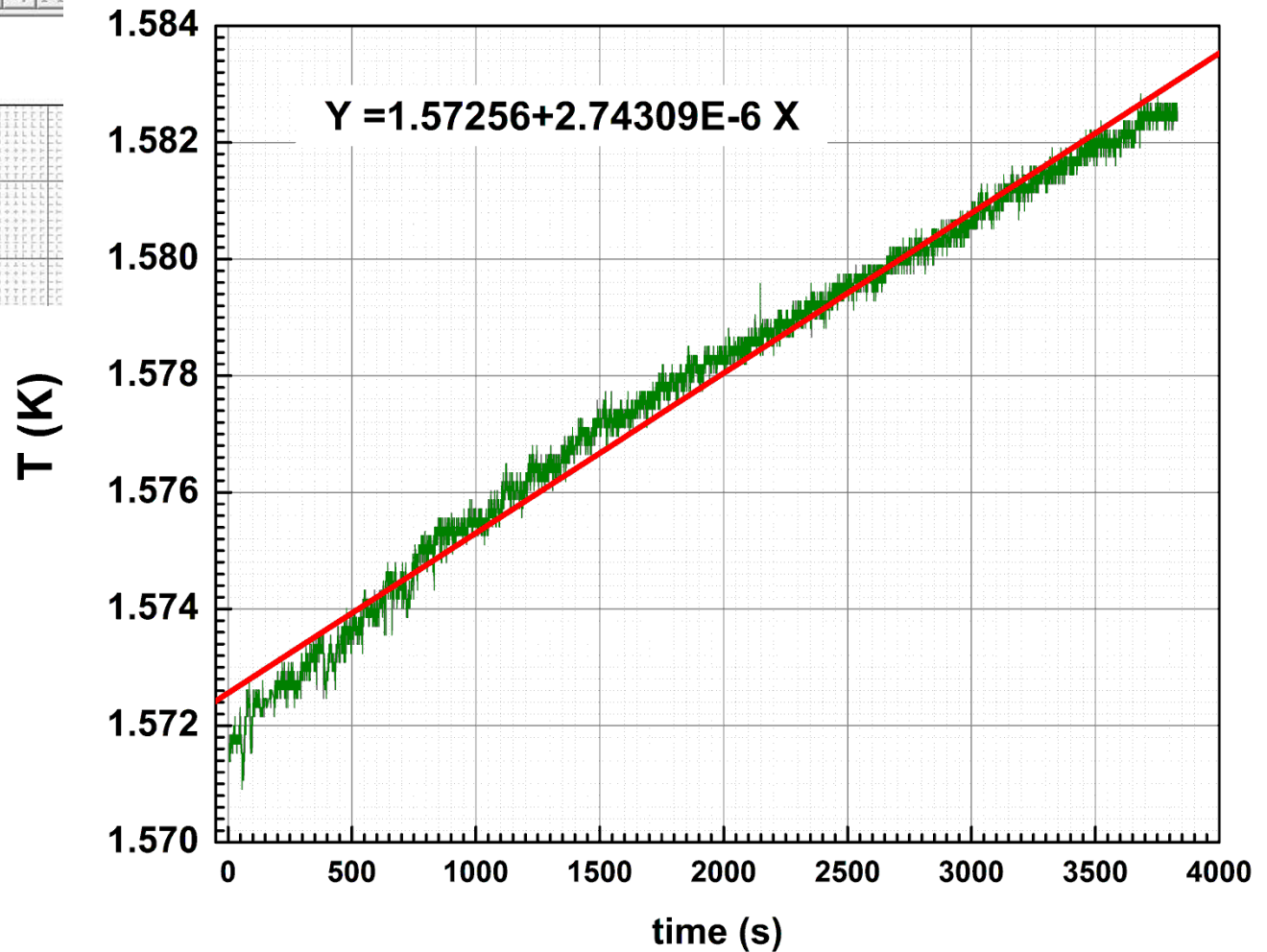
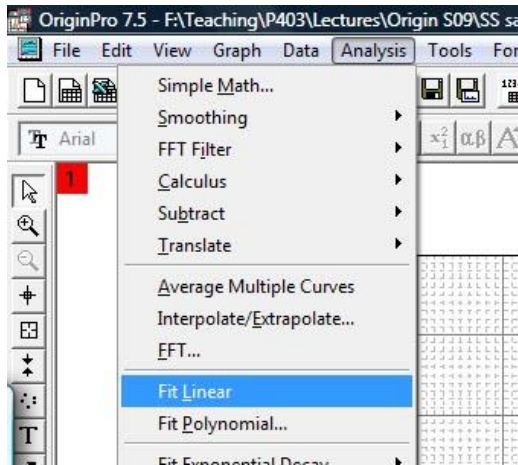

Graphical presentation of data: Fit Polynomial

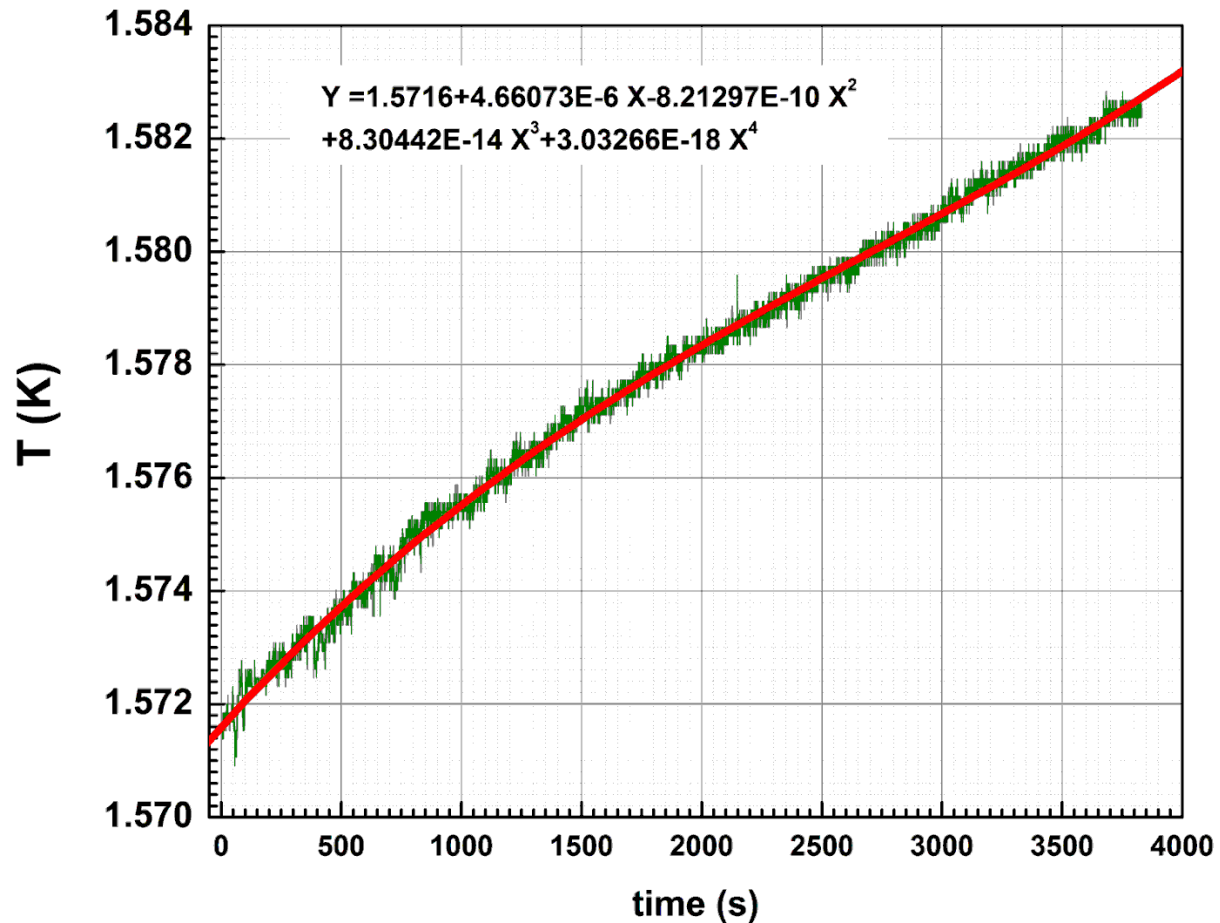
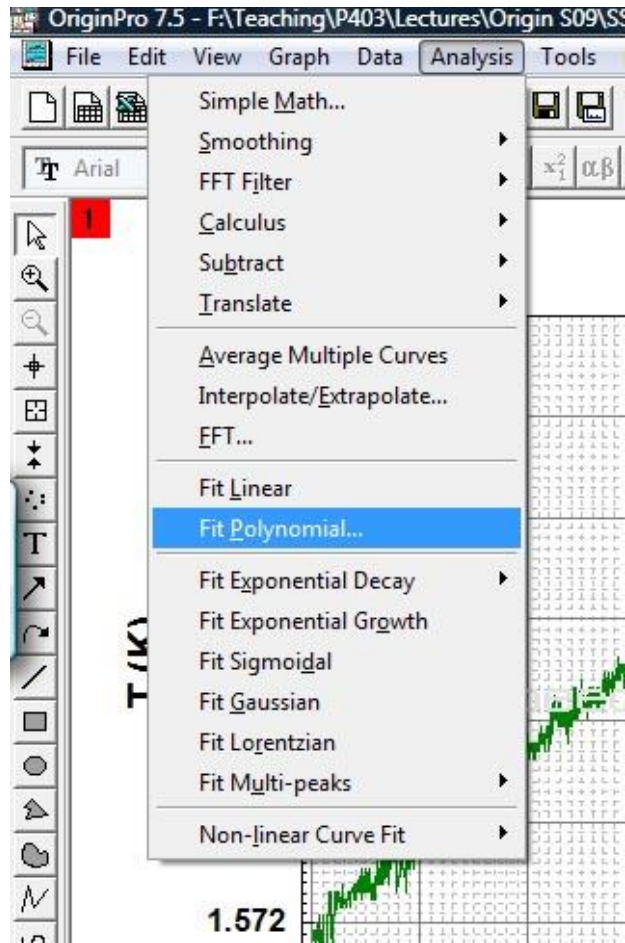

Graphical presentation of data: 2-layer graph

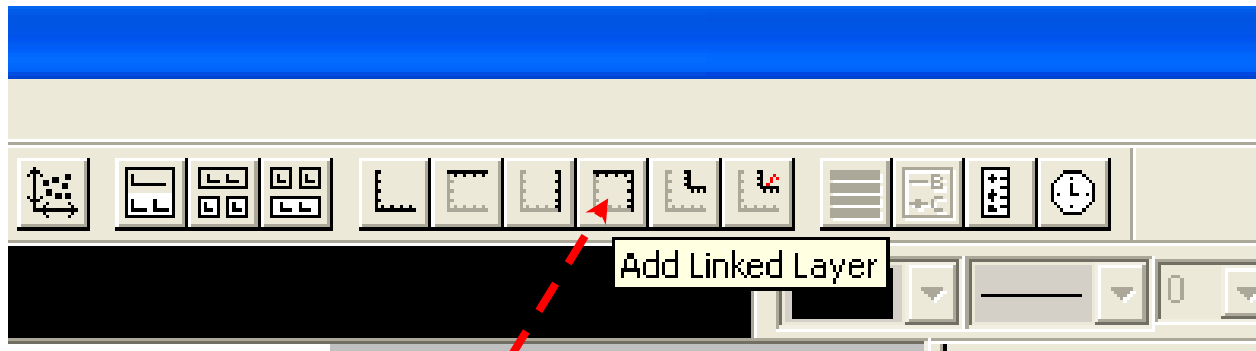

Add Layer

Second sound data

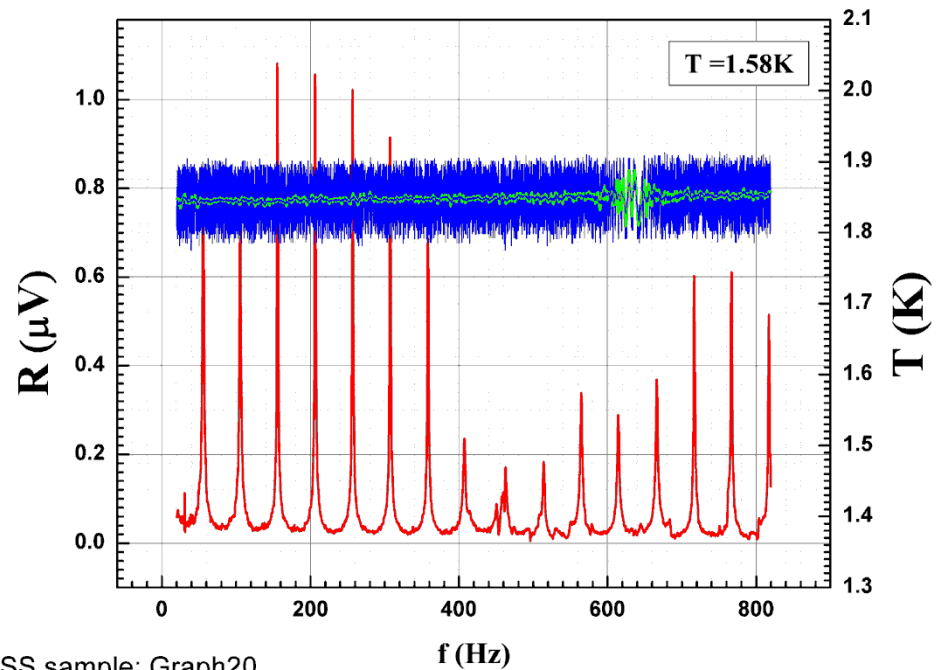

SS sample: Graph20

Graphical presentation of data: Smoothing

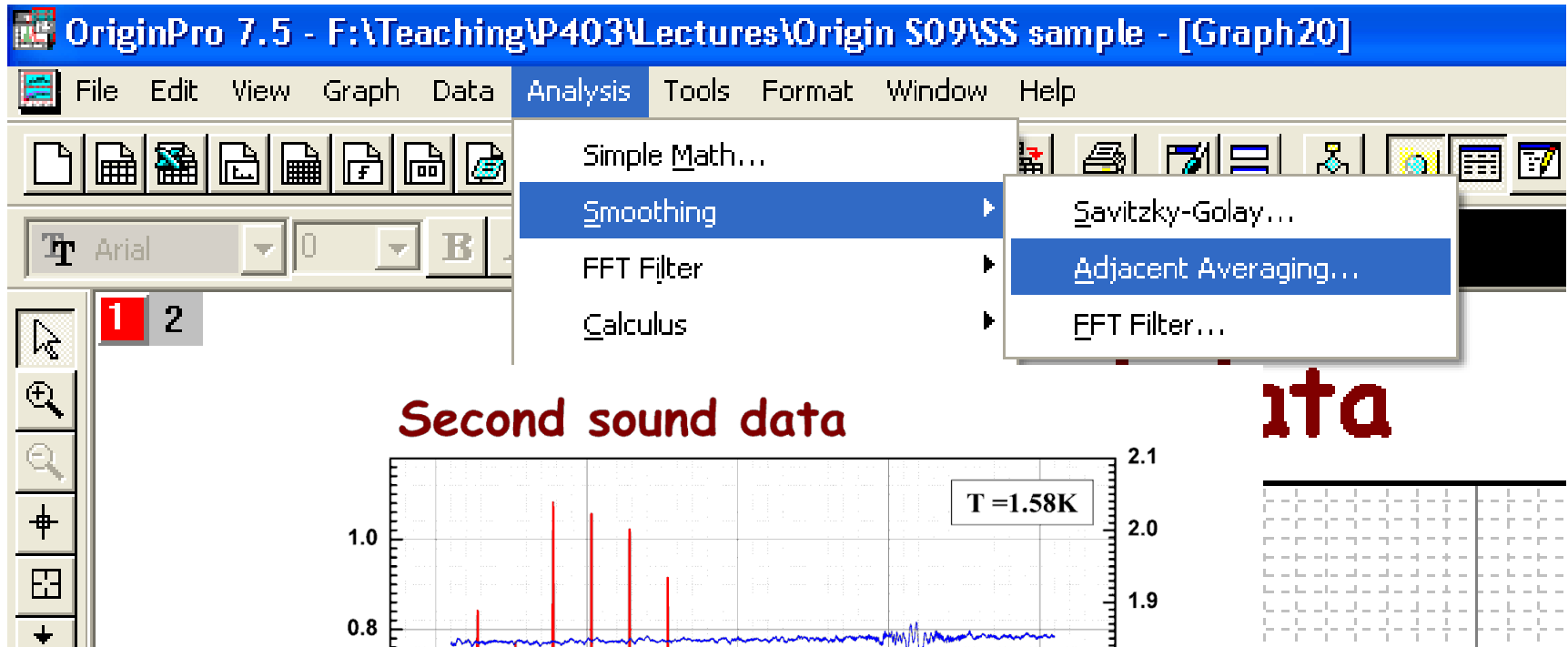

Second sound data

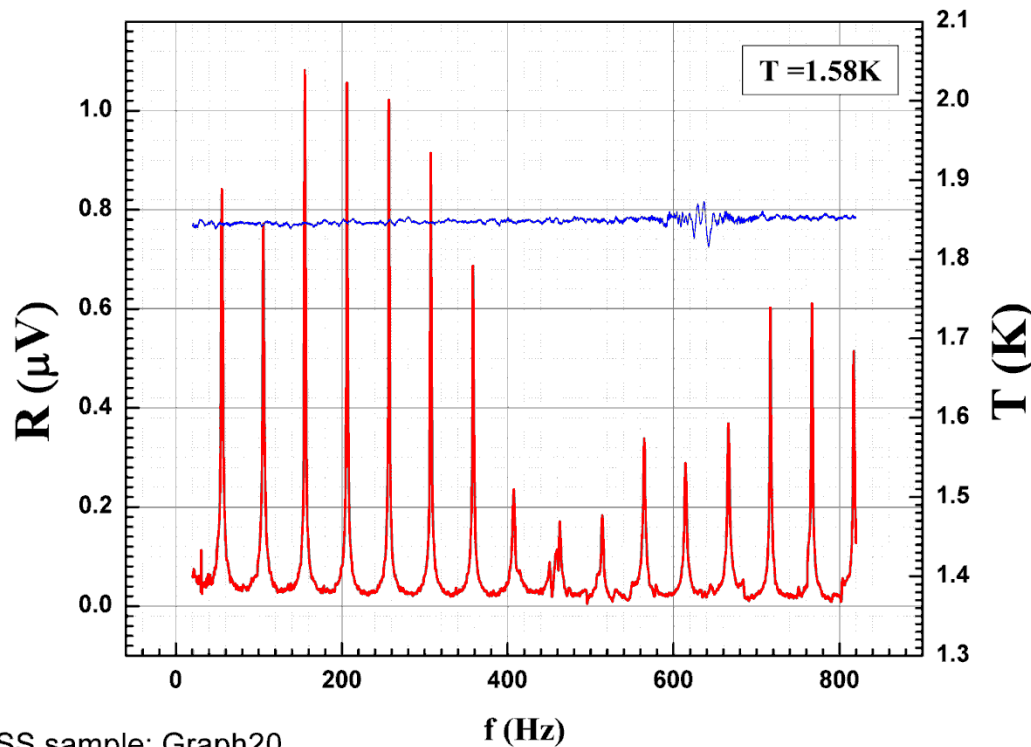

SS sample: Graph20

ita

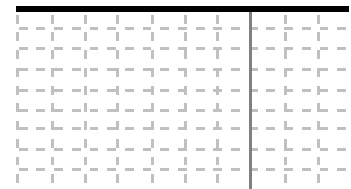

Working with data: Worksheets

The screenshot displays the OriginPro 2015 interface. The main window shows a worksheet with columns A(X) and B(Y). A context menu is open over column B(Y), with 'Statistics on Column...' selected. A separate window titled 'SecondSound2 - SecondSound_T2_16K VERY_BIG' displays the results of the statistics calculation for column T(K).

Main Worksheet Data:

	A(X)	B(Y)
Long Name	time (s)	T(K)
Units		
Comments		
F(x)=		
Sparklines		
1	5.35899	1.57
2	5.84299	1.57
3	6.281	1.57
4	6.71799	1.57
5	7.172	1.57
6	7.60899	1.57
7	8.437	1.57
8	8.906	1.57
9	9.39	1.57
10	9.85899	1.57
11	10.297	1.57
12	10.71799	1.57
13	11.156	1.57

Context Menu Options:

- Remove Links
- Set As
- Set As Categorical
- Set Column Values... (Ctrl+Q)
- Set Multiple Columns Values... (Ctrl+Shift+Q)
- Fill Column with
- Set Sampling Interval...
- Show X Column...
- Filter
- Mask
- Mask Cells by Condition...
- Sort Column
- Sort Worksheet
- Sort Columns by Label...
- Reverse Order
- Normalize...
- Frequency Count...
- Statistics on Column...**
- Hide/Unhide Columns

Statistics Window Data:

	N total	Mean	Standard Deviation	Sum	Minimum	Median	Maximum
T(K)	49801	1.60112	0.0161	79737.52969	1.57091	1.60099	1.63058

Calculate statistics on the selected column(s) Average=1.60112 Sum=79737.52969 C

Working with data: Worksheets

The image shows a LabTalk software interface with two windows. The background window is a spreadsheet titled "SecondSound2 - SecondSound_T2_16K VERY_BIG". It has columns labeled A(X) through I(Y) and rows for metadata (Long Name, Units, Comments, F(x)=, Sparklines) and data (rows 1-19). A context menu is open over column B, with "Set Column Values..." selected. The foreground window is "Set Values - [SecondSound2]\"SecondSound_T2_16K VE...". It has tabs for Formula, wcol(I), Col(A), Function, Variables, and Options. The "Formula" tab is active, showing "Row (i): From <auto> To <auto>" and "Col(B) = col(B) - 273". The "Before Formula Scripts" section contains the text: "Enter LabTalk script to define variables or execute calculation before formula." A large blue arrow points from the "Set Values" dialog back to the spreadsheet.

	A(X)	B(Y)	C(Y)	D(Y)	E(Y)	F(Y)	G(Y)	H(Y)	I(Y)
Long Name	time (s)	T(K)				f (Hz)	X (V)	Y(V)	R(V)
Units									
Comments									
F(x)=									
Sparklines									
1	5.35899	1.571							
2	5.84299	1.571							
3	6.281	1.571							
4	6.71799	1.571							
5	7.172	1.571							
6	7.60899	1.571							
7	8.437	1.571							
8	8.906	1.571							
9	9.39	1.571							
10	9.85899	1.571							
11	10.297	1.571							
12	10.71799	1.571							
13	11.156	1.571							
14	11.59299	1.571							
15	12.031	1.571							
16	12.46799	1.571							
17	12.89	1.571							
18	13.312	1.571							
19	13.73399	1.571							

Layouts

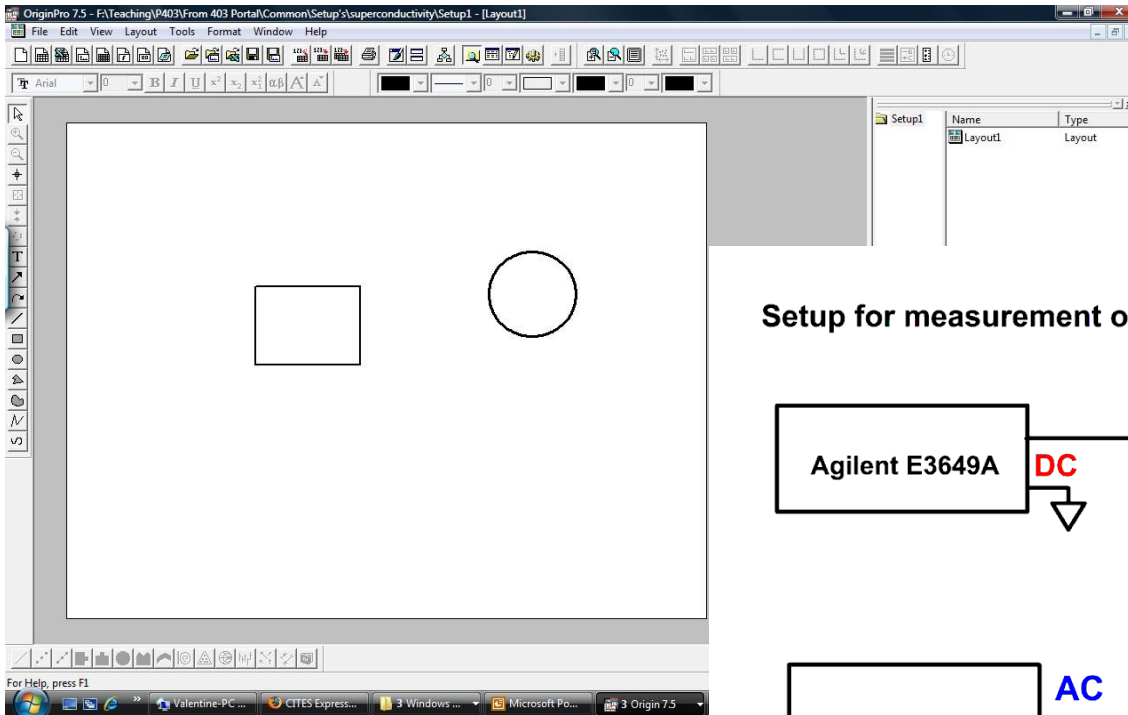

Setup for measurement of s/c properties

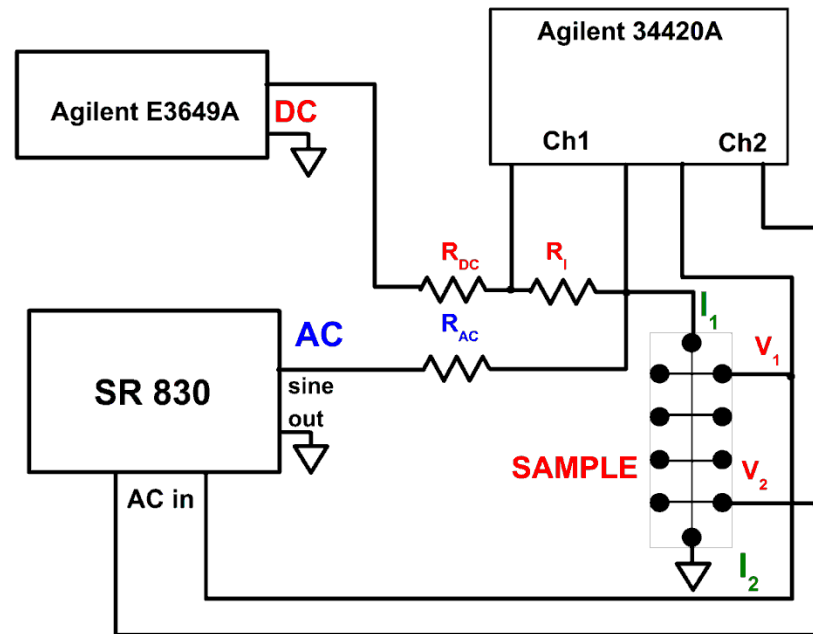

Custom tools

The screenshot shows the OriginPro 2015 (Academic) 64-bit interface. The main window displays a spreadsheet titled 'Book1' with columns 'A(X)' and 'B(Y)'. The spreadsheet contains the following data:

	A(X)	B(Y)
Long Name		
Units		
Comments		
F(x)=		
1		
2		
3		
4		
5		
6		
7		
8		
9		
10		
11		

The 'Tools' menu is open, showing the following options:

- Options... (Ctrl+U)
- Fitting Function Builder... (F8)
- Virtual Matrix Manager...
- Transfer User Files...
- Digitizer...** (highlighted)
- Video Builder...

The interface also includes a Project Explorer (1) on the left, a Quick Help pane, a Messages Log, and a Smart Hint Log. The status bar at the bottom indicates 'Sheet1'.

Using digitizer script

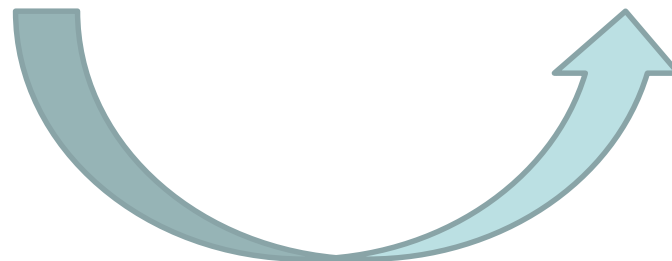
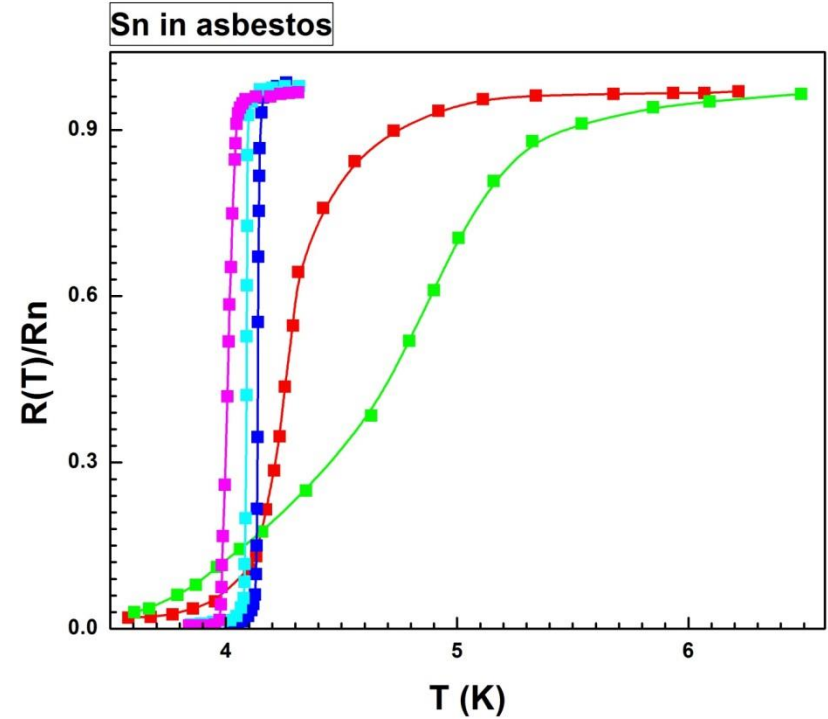
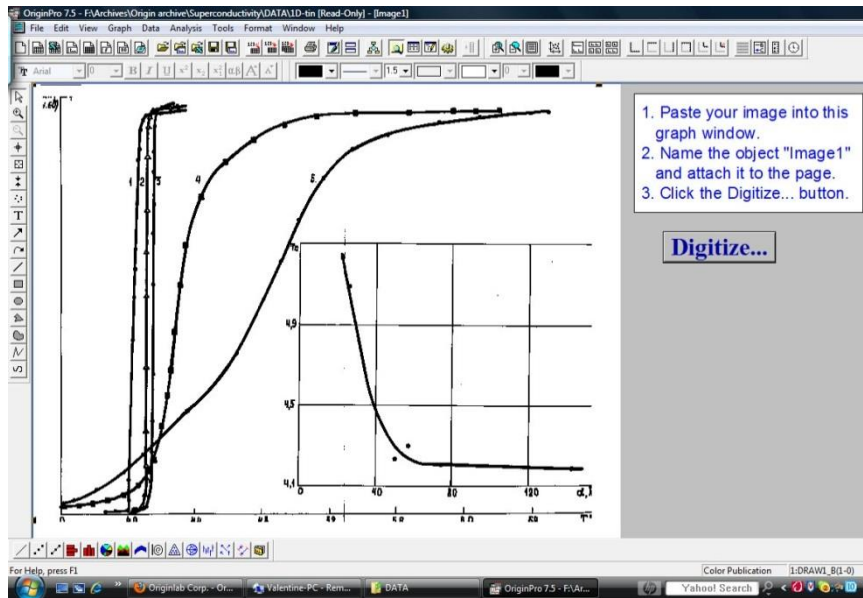

Origin at UIUC Webstore and OriginLab site.

UNIVERSITY OF ILLINOIS
URBANA-CHAMPAIGN • CHICAGO • SPRINGFIELD

SHOP ► Unit Purchase Personal Purchase

HOME ABOUT US EVENTS NEWS SUPPORT

WEBSTORE
Urbana-Champaign • Chicago • Springfield

PRODUCT SEARCH: GO BROWSE ALL

Home > Personal Purchase > Software > Free Software

My Account

Login: You are a Guest

My Profile

Order History

View Cart (0 items)

OriginPro 8.6

\$0.00

OriginLab OriginLab, Inc.

Eligibility: UIC Faculty, UIC Staff, UIC Students, UIS Faculty, UIS Staff, UIS Faculty and Staff and UIUC Students.

<https://webstore.illinois.edu>

www.originlab.com

OriginLab Data Analysis and Graphing Software

Company Products Support Solutions Purchase Downloads

What's New!

- ★ Origin 8.6 is Now Available! (11/15/2011)
- ★ Scientific Computing World review (7/1/2011)

- Graph Gallery
- Origin Viewer
- Pricing & Purchase
- License/Register
- Online Help
- Reviews
- Case Studies
- Service Releases
- Video Tutorials
- Student Personal Use
- Government & GSA Pricing
- Licensing Options
- User Forums
- File Exchange
- Wiki
- LabVIEW™ Connectivity

ORIGIN 8.6 DATA ANALYSIS GRAPHING PROGRAMMING

Origin is an easy-to-use data analysis and graphing software application used by over 100,000 scientists and engineers worldwide. OriginPro offers all of the features of Origin plus extended analysis tools. Compare Origin and OriginPro.

Origin 8.6 (November 2011)

Try Now Buy Now Watch Now

Graph Gallery New Features



Origin manuals



Working with Origin 8.6.

Step1. Importing data

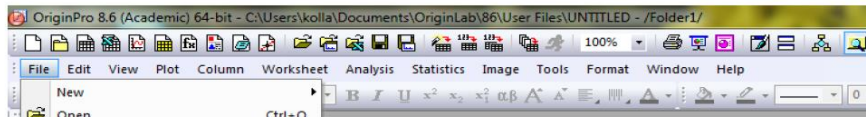

A very short and simple manual covering only the main operations with Origin, and manuals from Origin are on the server ([\\Phyapportal\PHYCS403\Common\Origin manuals](http://Phyapportal\PHYCS403\Common\Origin manuals)).

Do not forget about Origin Help

Video Tutorials on the company website

OriginLab® Data Analysis and Graphing Software					
Company	Products	Support	Solutions	Purchase	D
Help Center		SUPPORT : VIDEO TUTORIALS			
Video Tutorials		Video Tutorials			
User Forum					

<http://www.originlab.com/index.aspx?go=SUPPORT/VideoTutorials>



Example Origin graphs

(PMN)_{0.87}(PT)_{0.13}, single crystal

Ferroelectric
Experiment

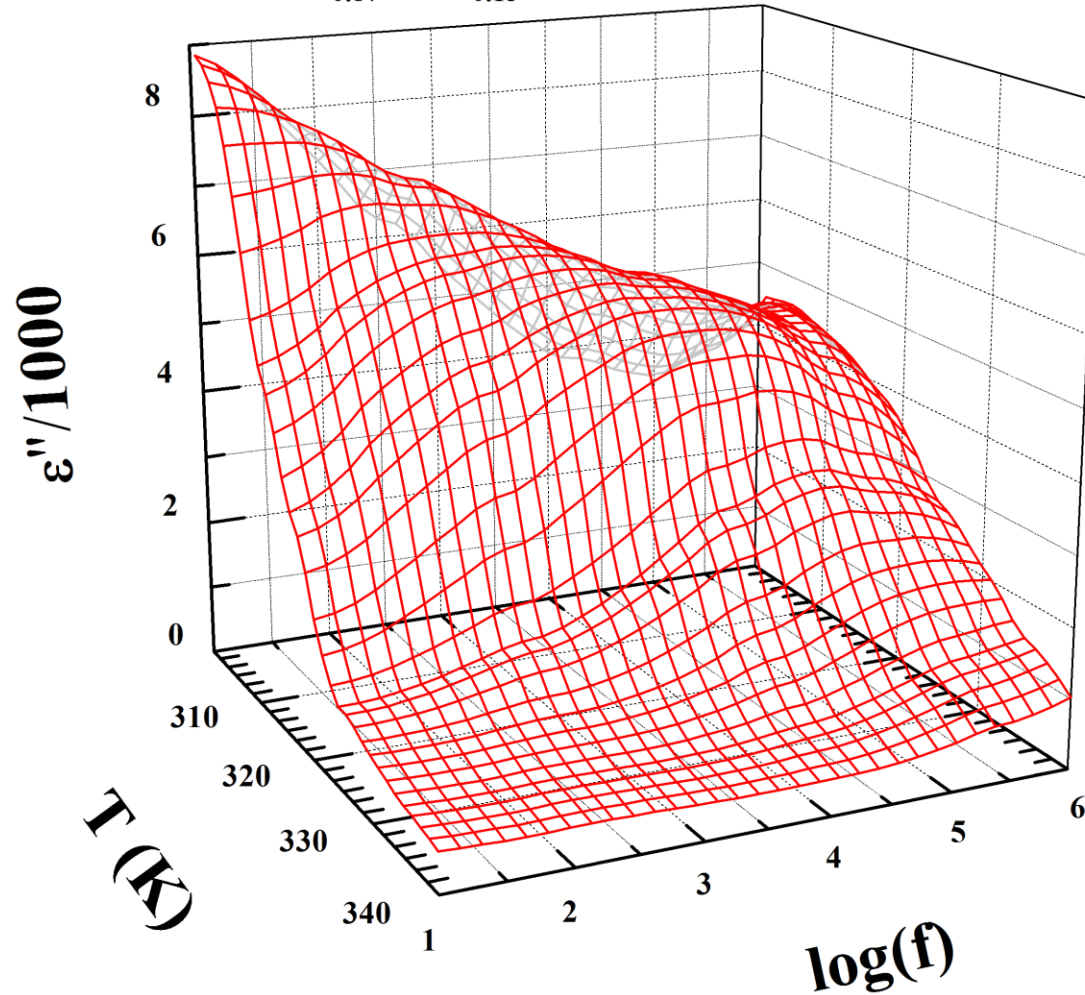

Example Origin graphs

Ferroelectric
Experiment

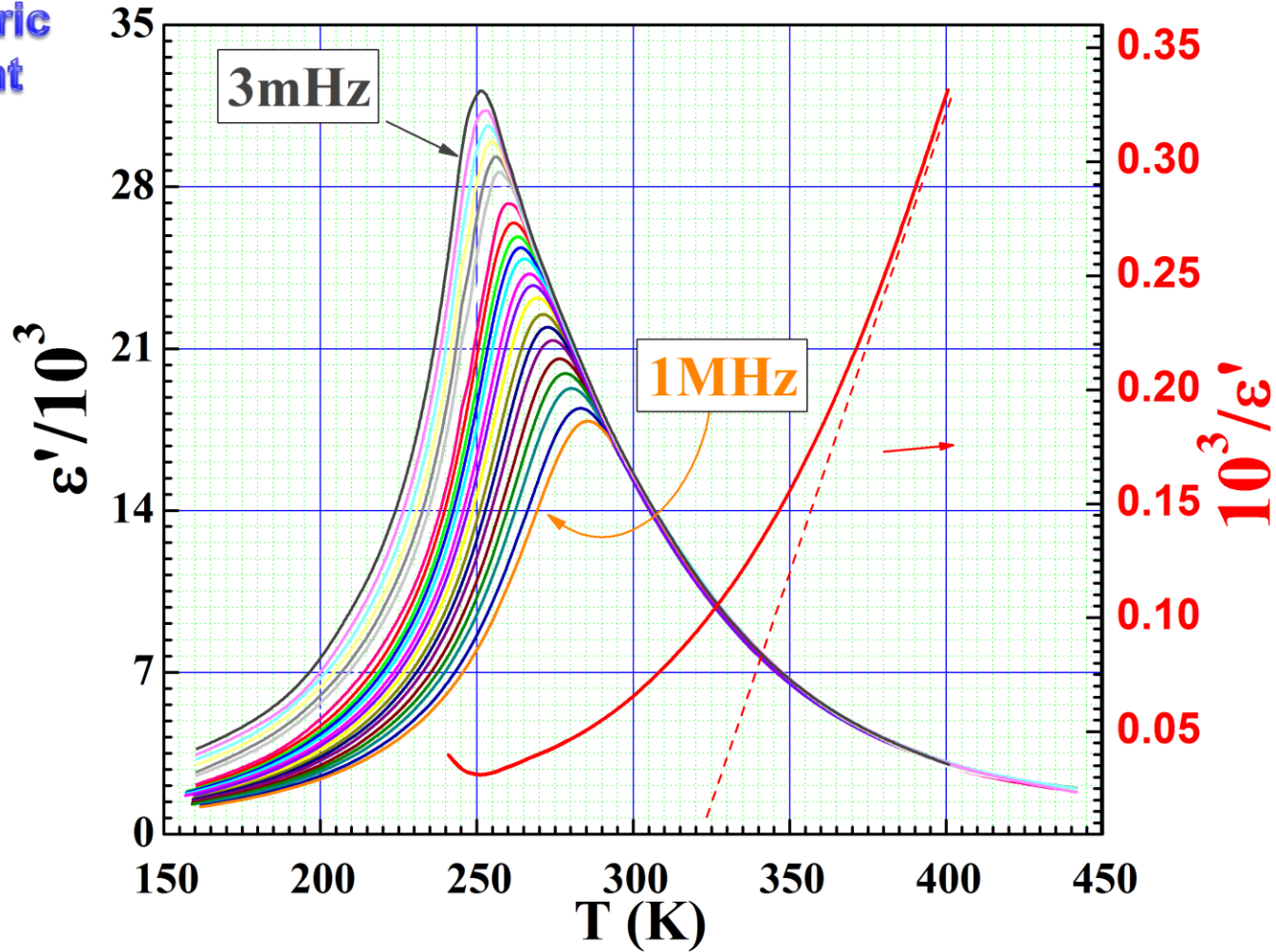

Example Origin graphs

Optical
pumping

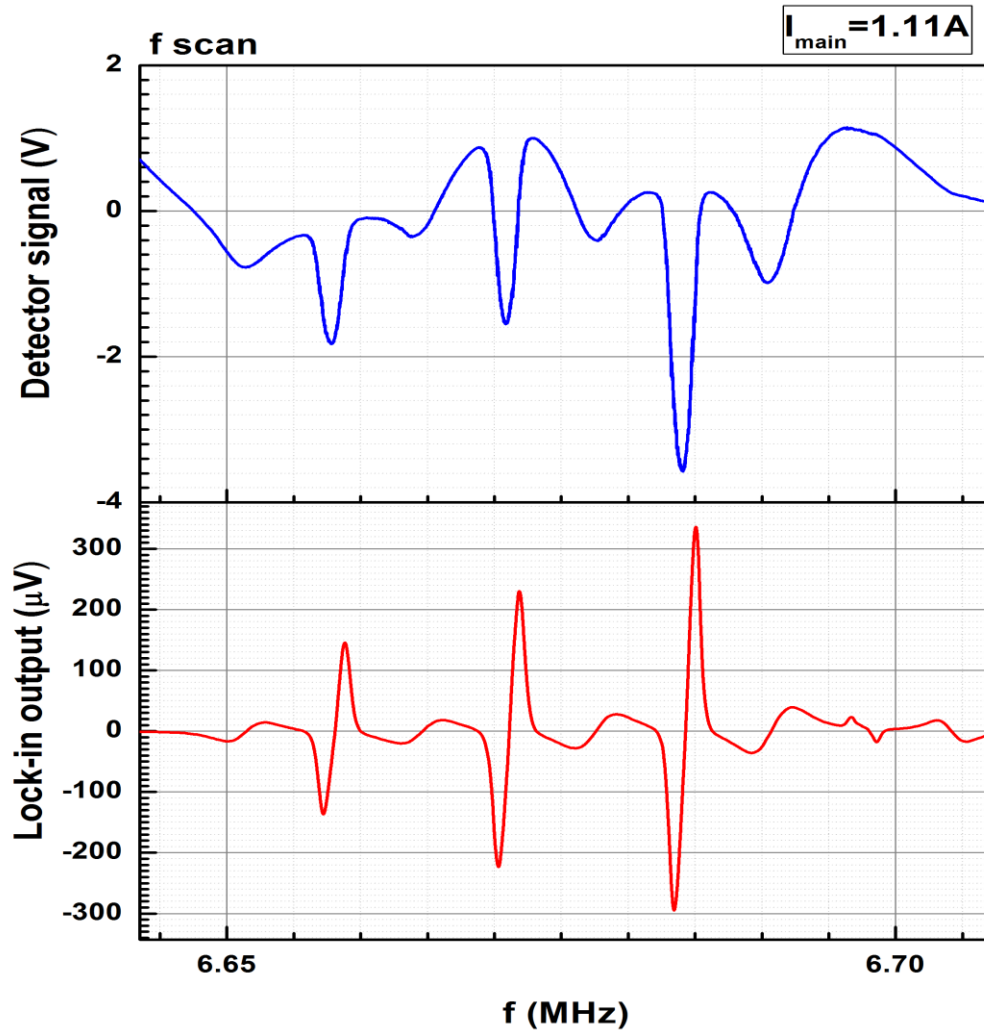

Mapping 0.5-2.5A from March 1st 2012: Graph7



Example Origin graphs

Tunneling
Experiment

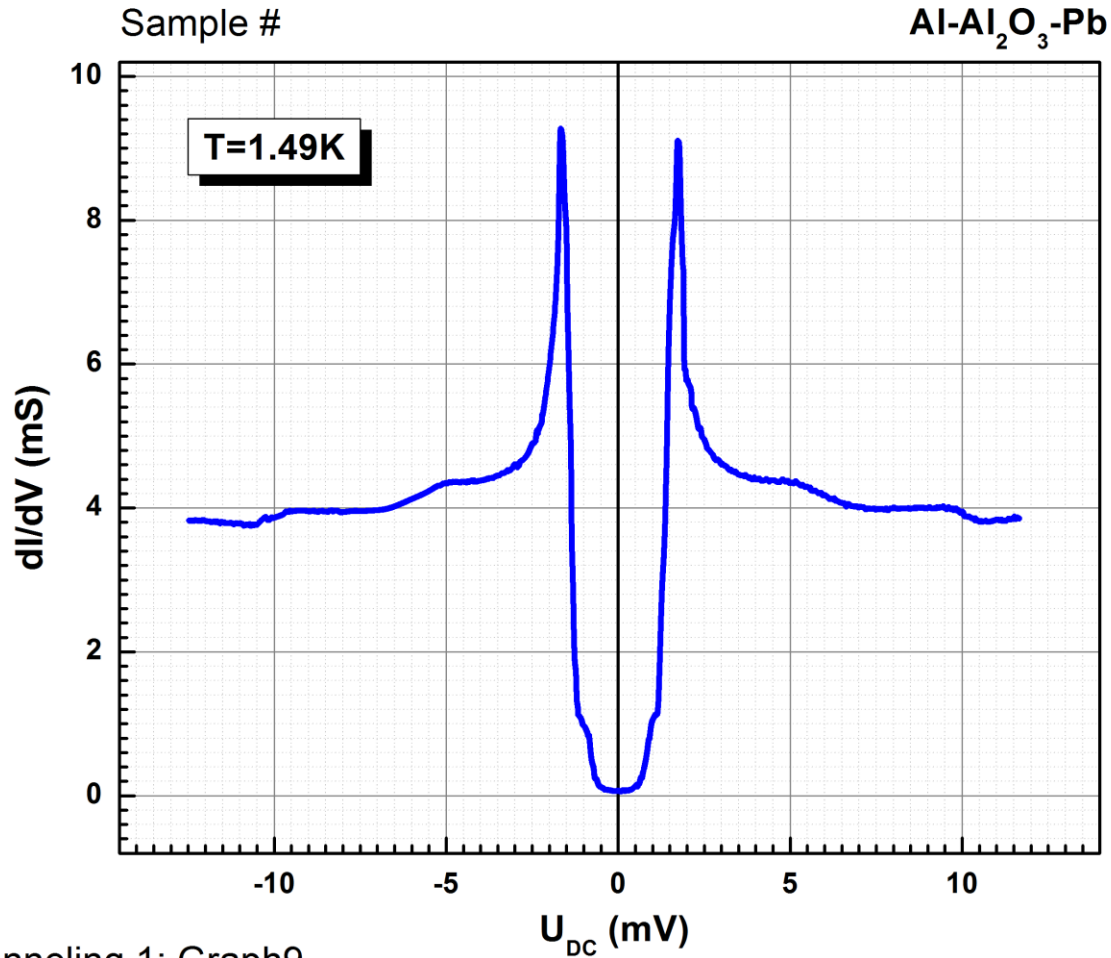

Tunneling 1: Graph9

Sample n2 run8 zoom temp 1.55K



Example Origin graphs

Second
sound

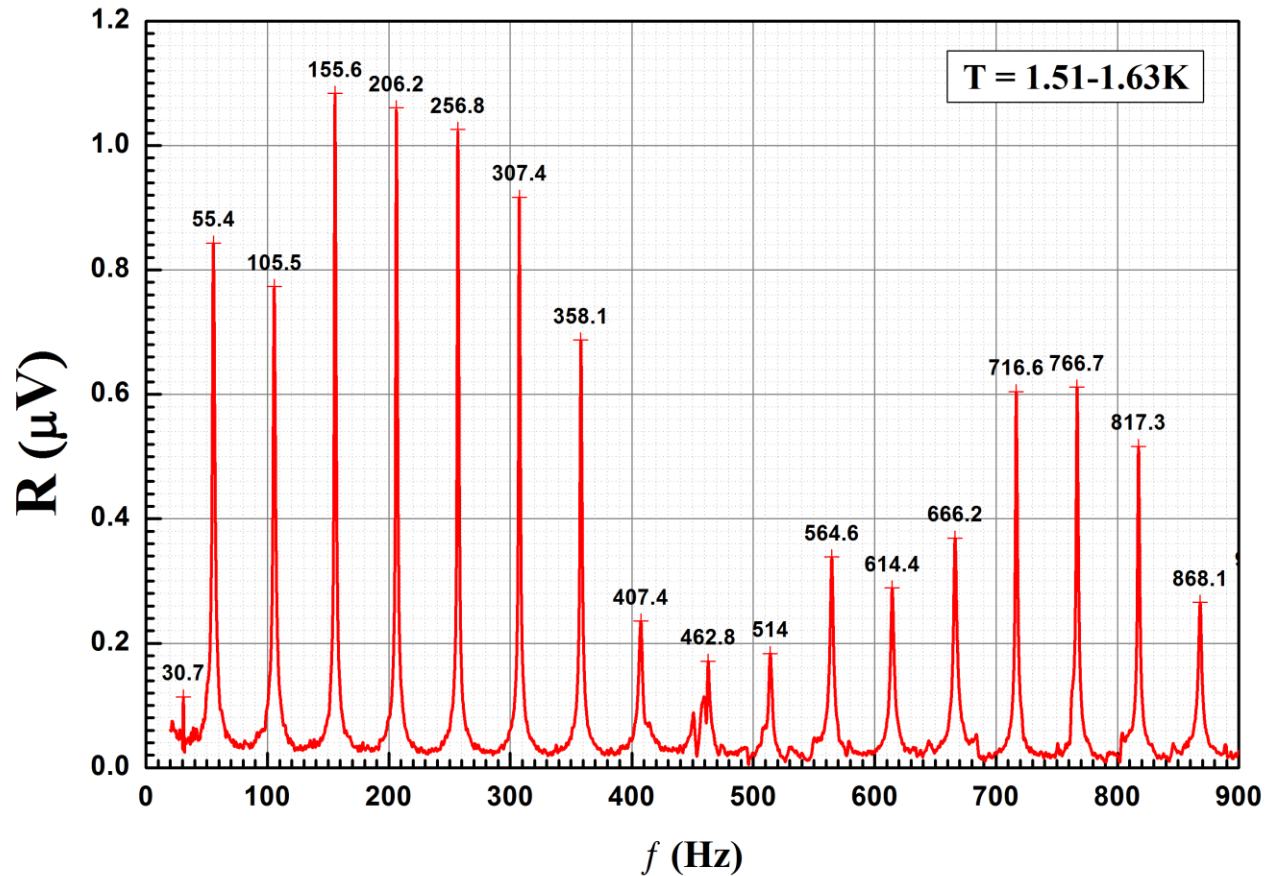

Example Origin graphs

Magnet mapping

