

Temperature. Sensors. Measuring technique.

Eugene V. Colla

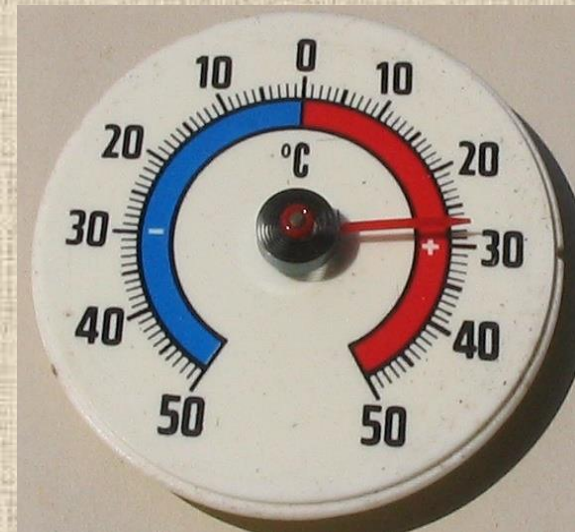

Outline

Temperature Sensors

Measuring equipment and ideas

Sensor calibration

Temperature scales

Notcontacting devices:

Pyrometers



Jožef Stefan
(1835-1893)

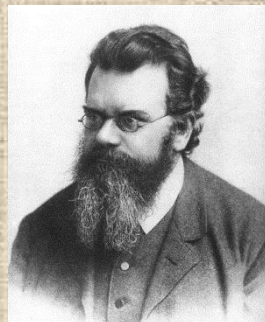

Ludwig Eduard Boltzmann
(1844-1906)

Stefan-Boltzmann law

$$P = e\sigma AT^4$$

e – emissivity;

σ - Stefan-Boltzmann constant

($\sigma = 5.67 \times 10^{-8} \text{ Wm}^{-2}\text{K}^{-4}$)

A - surface area

T - temperature

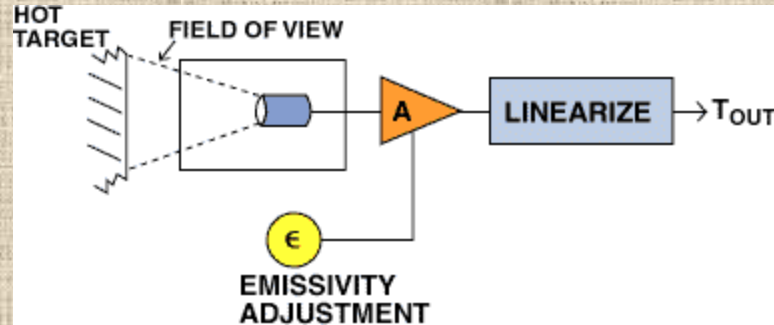

OS643



Range C°
0÷260



**Extech
42545**

Range C°
-50÷1000



Range C°
-40÷500

**Extech
42580**

Contacting devices: Bi-Metal Thermometers



Typical temperature range
 $-10^{\circ}\text{C} \div 200^{\circ}\text{C}$

- Very cheap
- No electronics
- Easy to use
- Moderate precision ($\pm 1\%$ from full scale)

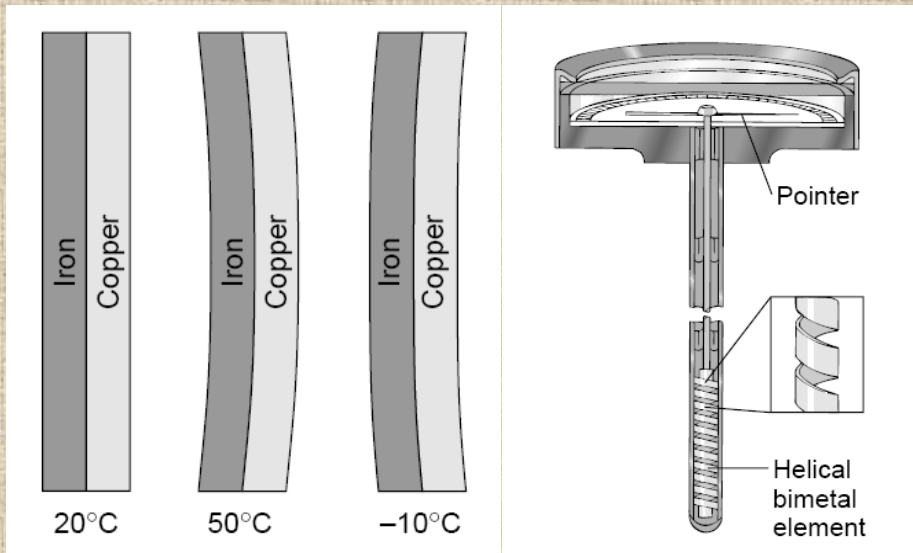

Contacting devices: Volume Expansion Thermometer

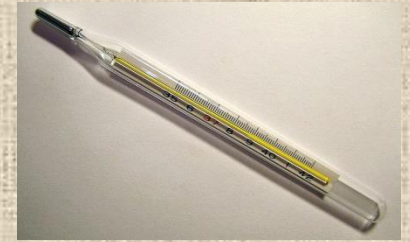

$$\Delta V = V \beta \Delta T$$

β –coefficient of volume expansion

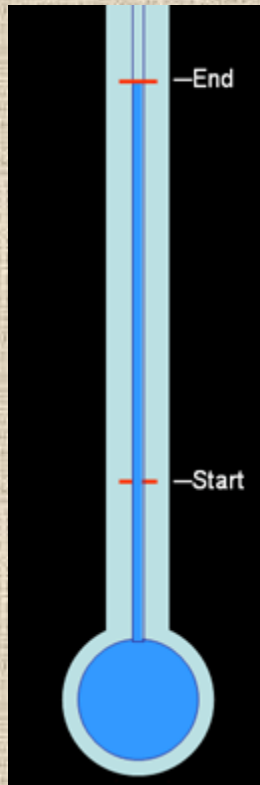

Average Expansion Coefficients for Some Materials Near Room Temperature

Material	Average Coefficient of Linear Expansion (α) ($^{\circ}\text{C}^{-1}$)	Material	Average Coefficient of Volume Expansion (β) ($^{\circ}\text{C}^{-1}$)
Aluminum	24×10^{-6}	Acetone	1.5×10^{-4}
Brass and bronze	19×10^{-6}	Alcohol, ethyl	1.12×10^{-4}
Copper	17×10^{-6}	Benzene	1.24×10^{-4}
Glass (ordinary)	9×10^{-6}	Gasoline	9.6×10^{-4}
Glass (Pyrex)	3.2×10^{-6}	Glycerin	4.85×10^{-4}
Lead	29×10^{-6}	Mercury	1.82×10^{-4}
Steel	11×10^{-6}	Turpentine	9.0×10^{-4}
Invar (Ni-Fe alloy)	0.9×10^{-6}	Air ^a at 0°C	3.67×10^{-3}
Concrete	12×10^{-6}	Helium ^a	3.665×10^{-3}

Contacting devices: Seebeck Effect. Thermocouples



Thomas Johann Seebeck
(1770-1831)

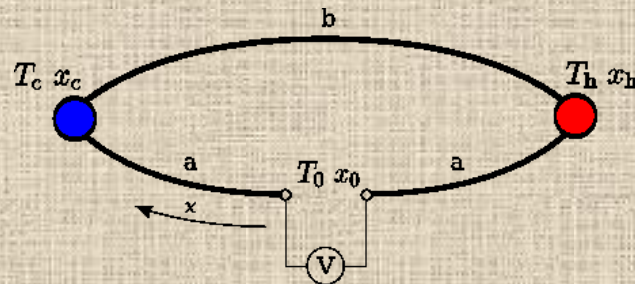
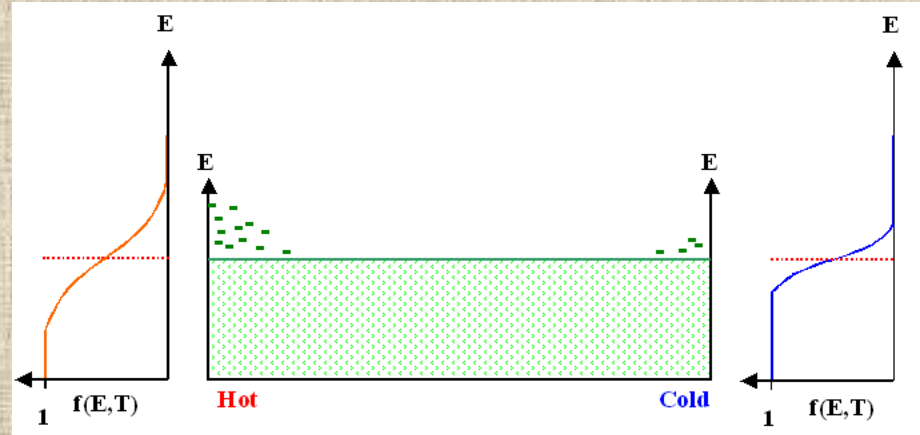
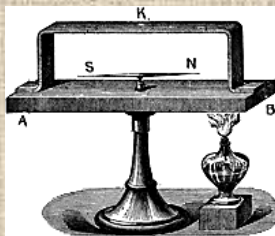

$$S = \frac{dU}{dT}$$

$$U_S = \int_{T_0}^{T_c} S_A dT + \int_{T_c}^{T_H} S_B dT + \int_{T_H}^{T_0} S_A dT = \int_{T_c}^{T_H} (S_B - S_A) dT$$

S -Seebeck coefficient

Contacting devices: Seebeck Effect. Thermocouples

Seebeck coefficients

Material	Seebeck Coeff. *	Material	Seebeck Coeff. *	Material	Seebeck Coeff. *
Aluminum	3.5	Gold	6.5	Rhodium	6.0
Antimony	47	Iron	19	Selenium	900
Bismuth	-72	Lead	4.0	Silicon	440
Cadmium	7.5	Mercury	0.60	Silver	6.5
Carbon	3.0	Nichrome	25	Sodium	-2.0
Constantan	-35	Nickel	-15	Tantalum	4.5
Copper	6.5	Platinum	0	Tellurium	500
Germanium	300	Potassium	-9.0	Tungsten	7.5

*: Units are $\mu\text{V}/^\circ\text{C}$; all data provided at a temperature of 0°C

Type T (copper-constantan) has thermoemf at 0°C $41.5\mu\text{V}/^\circ\text{C}$;

Contacting devices:

Thermocouple Type	Names of Materials	Useful Application Range
B	Platinum 30% Rhodium (+) Platinum 6% Rhodium (-)	2500 -3100F 1370-1700C
C	W5Re Tungsten 5% Rhenium (+) W26Re Tungsten 26% Rhenium (-)	3000-4200F 1650-2315C
E	Chromel (+) Constantan (-)	200-1650F 95-900C
J	Iron (+) Constantan (-)	200-1400F 95-760C
K	Chromel (+) Alumel (-)	200-2300F 95-1260C
N	Nicrosil (+) Nisil (-)	1200-2300F 650-1260C
R	Platinum 13% Rhodium (+) Platinum (-)	1600-2640F 870-1450C
S	Platinum 10% Rhodium (+) Platinum (-)	1800-2640F 980-1450C
T	Copper (+) Constantan (-)	-330-660F -200-350C

Thermocouples

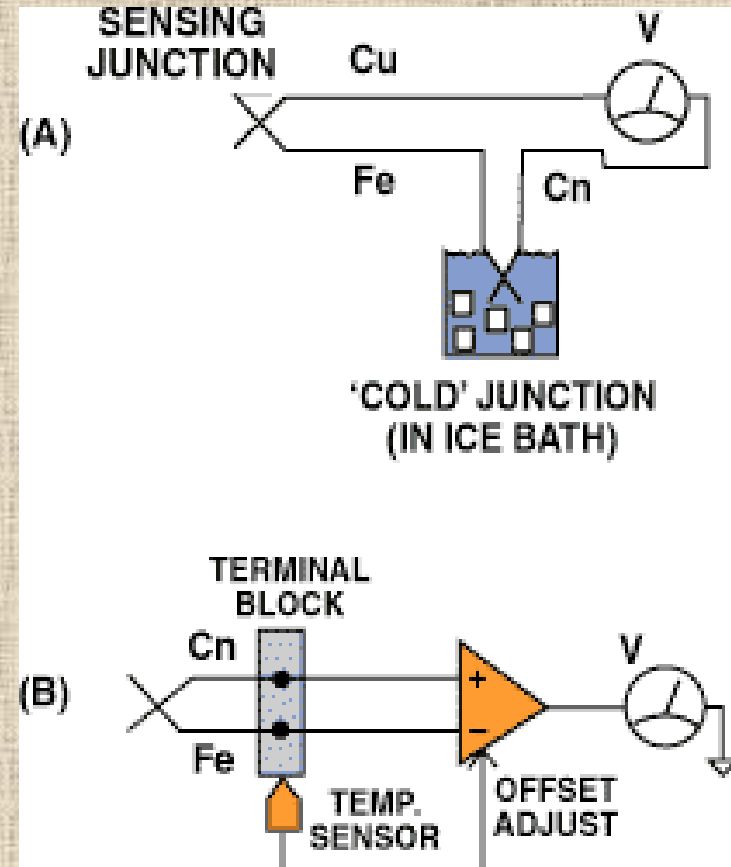

Contacting devices:

emf (T) dependence

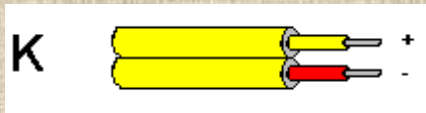

Thermocouples

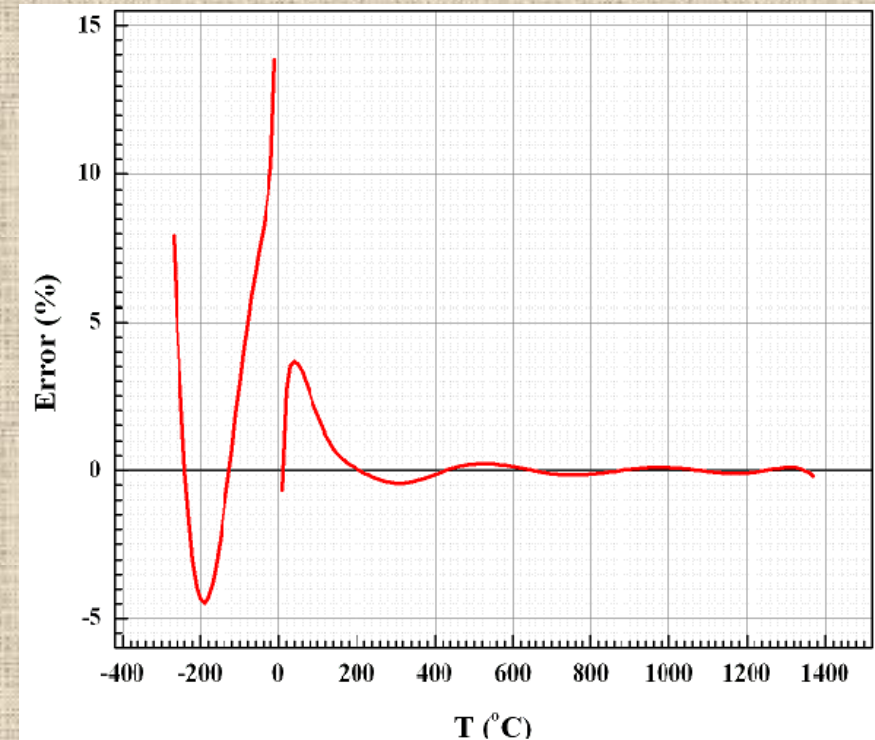
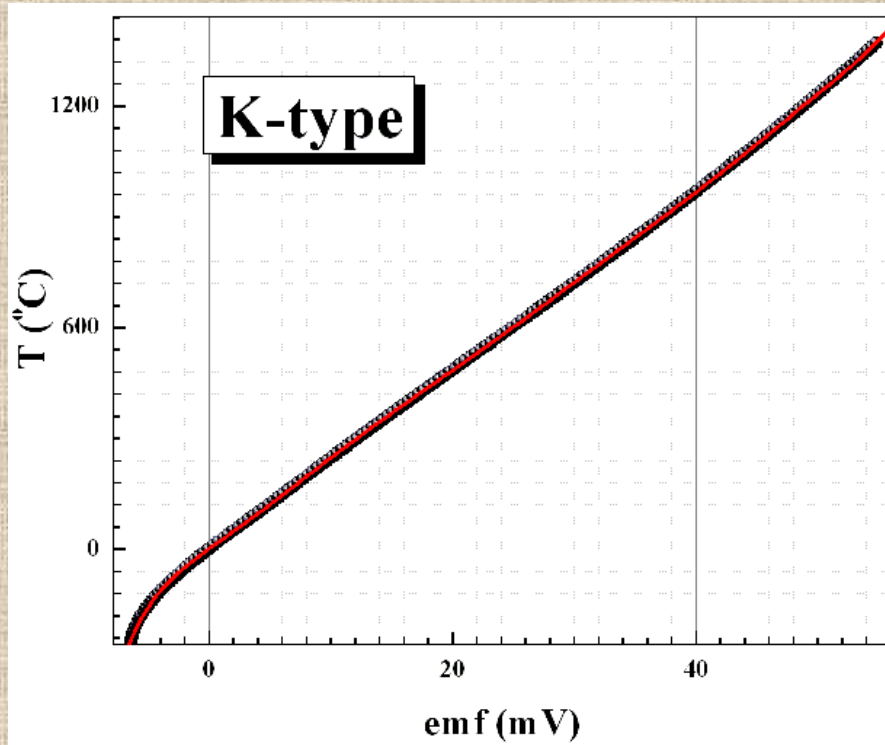

9th order polynomial fit

To reduce the error we have to split the temperature range in to a couple of segments

Contacting devices:

LakeShore

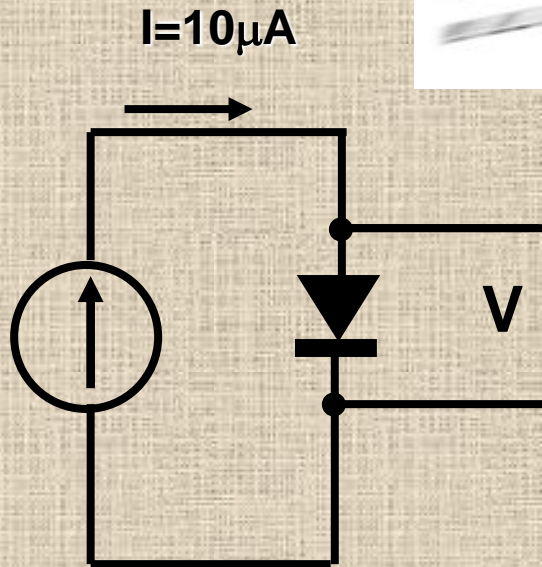

DT-470-SD Features:

1. Monotonic temperature response from 1.4 K to 500 K.
2. Conformance to standard Curve 10 temperature response curve
3. Useful above 60 K in magnetic fields up to 5 T

p-n diodes

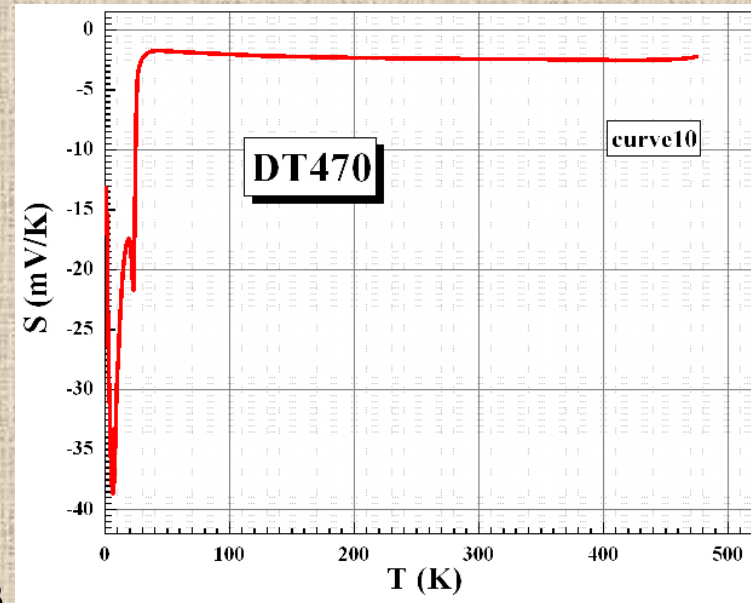
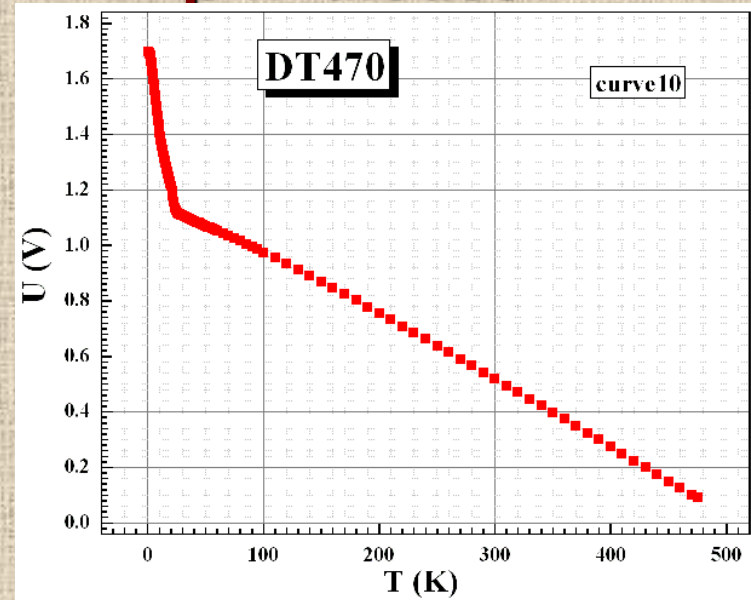

Silicon diode DT470

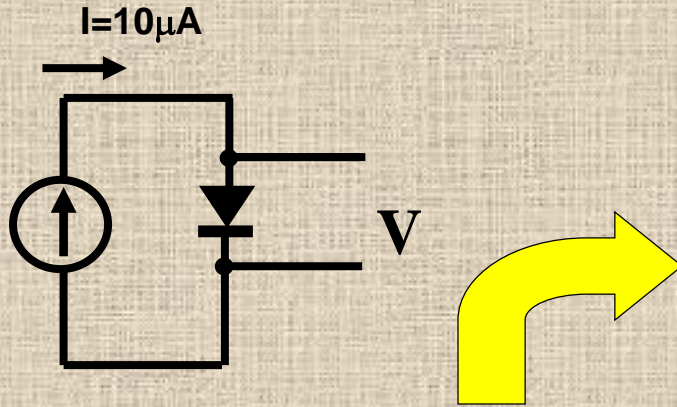

Calibration problems

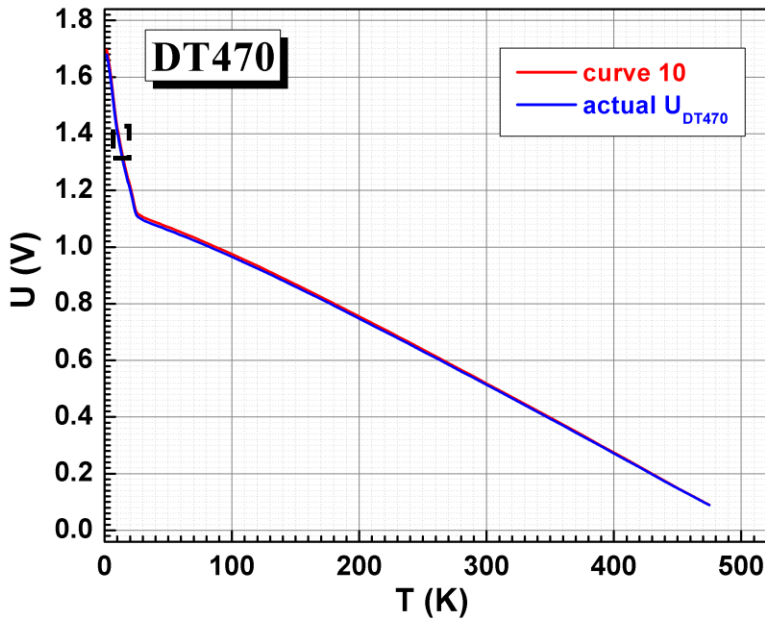
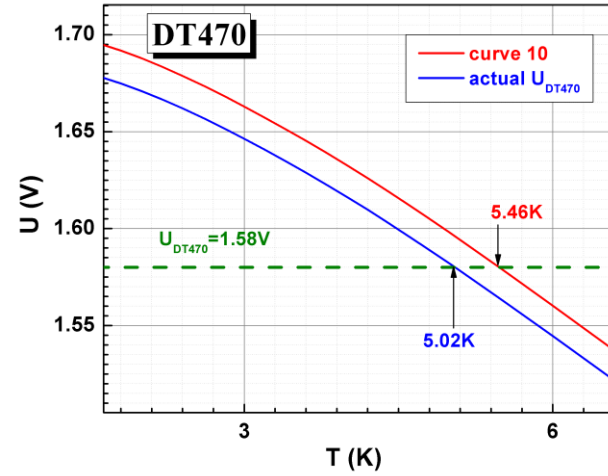

$$U^* = U_{DT470} \cdot k$$

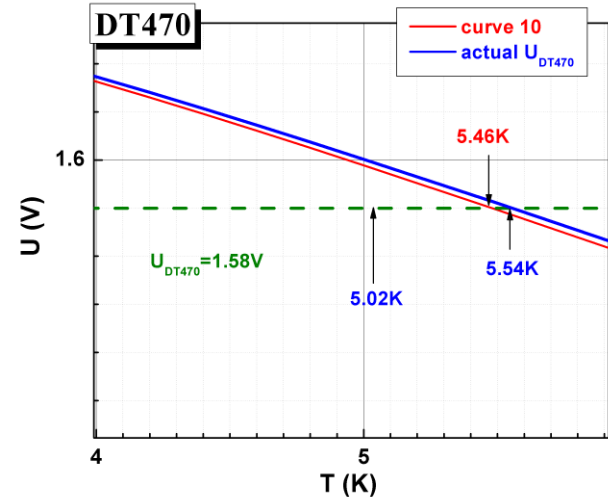

Contacting devices:

Resistance Temperature Detectors

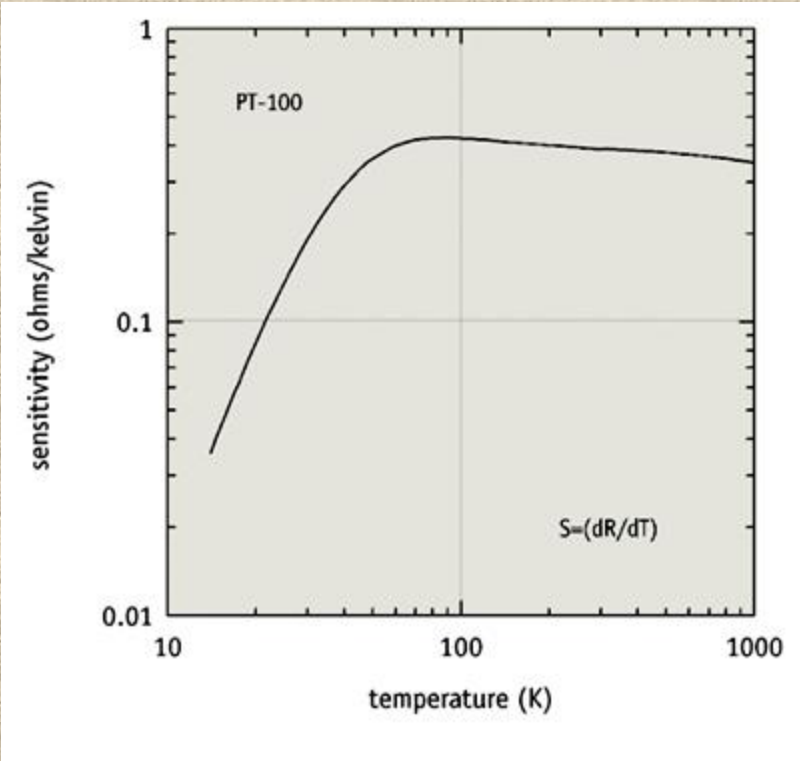
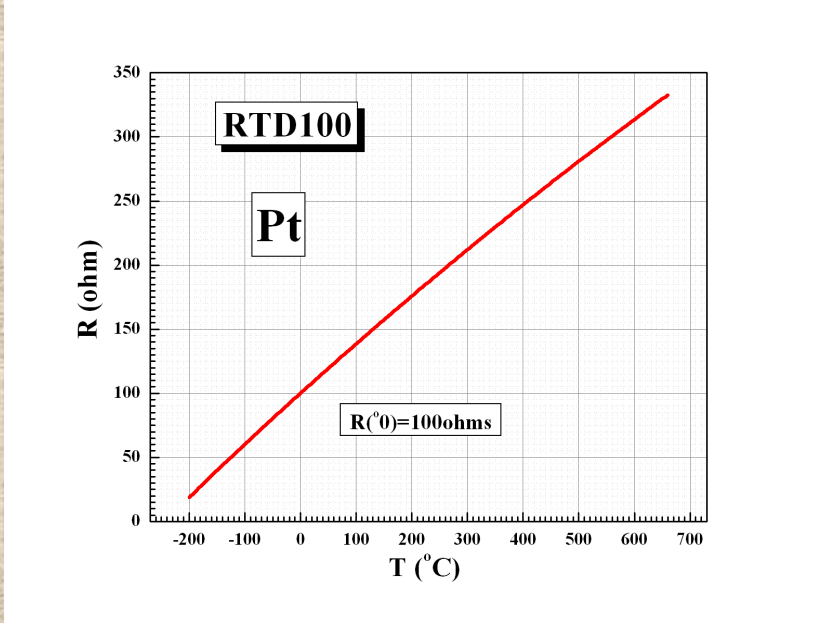

RTD Features:

- 1. Temperature range: 14 K to 873 K
- 2. High reproducibility: ± 5 mK at 77 K
- 3. Low magnetic field dependence above 40 K
- 4. Excellent for use in ionizing radiation

Measuring issue:

Four probe technique

NB!

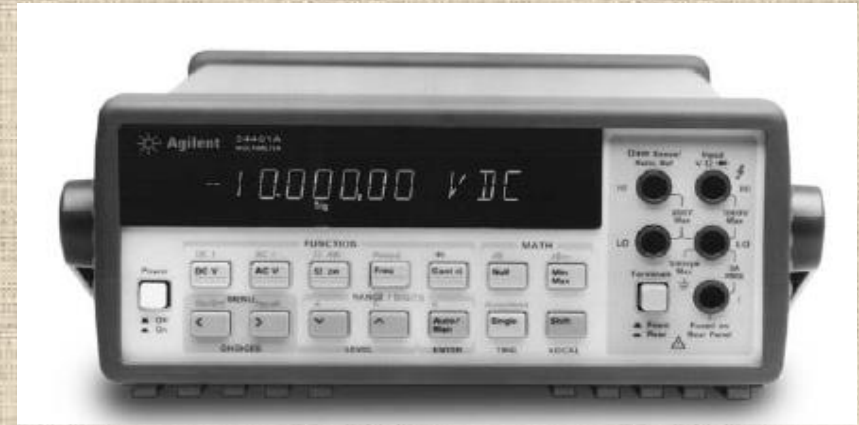
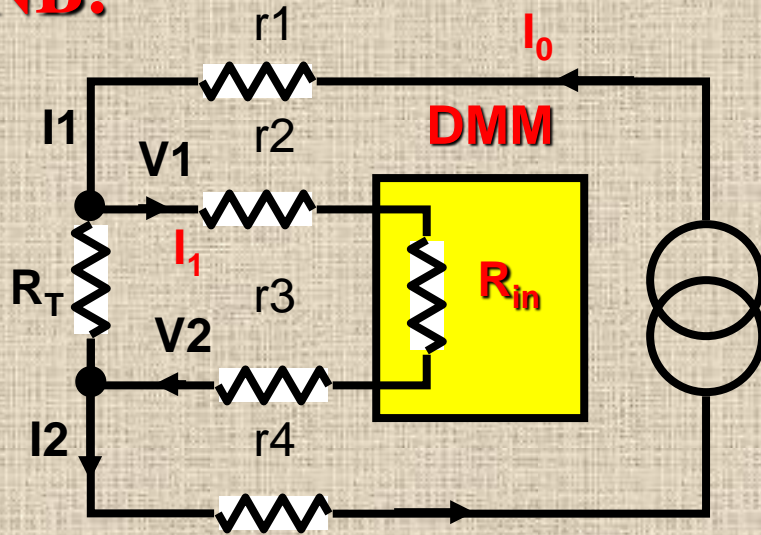

Most of DMM's have four probe option for resistance measurements.

If the sensor is mounted in cryostat the overall leads resistance could reach a couple of ohms. This will in case of RTD100 the resistance at 0°C is 100Ω give an error of a couple percent!

$$I_1 = I_0 * R_T / (r_2 + r_3 + R_{in}) \sim 0$$

$$R_{in} \sim 10^{10} \Omega$$

Vapor Pressure Thermometry

He4 P-T phase diagram

$$T_{90}/K = A_0 + \sum_{i=1}^9 A_i [(\ln(p/\text{Pa}) - B)/C]^i \quad (3)$$

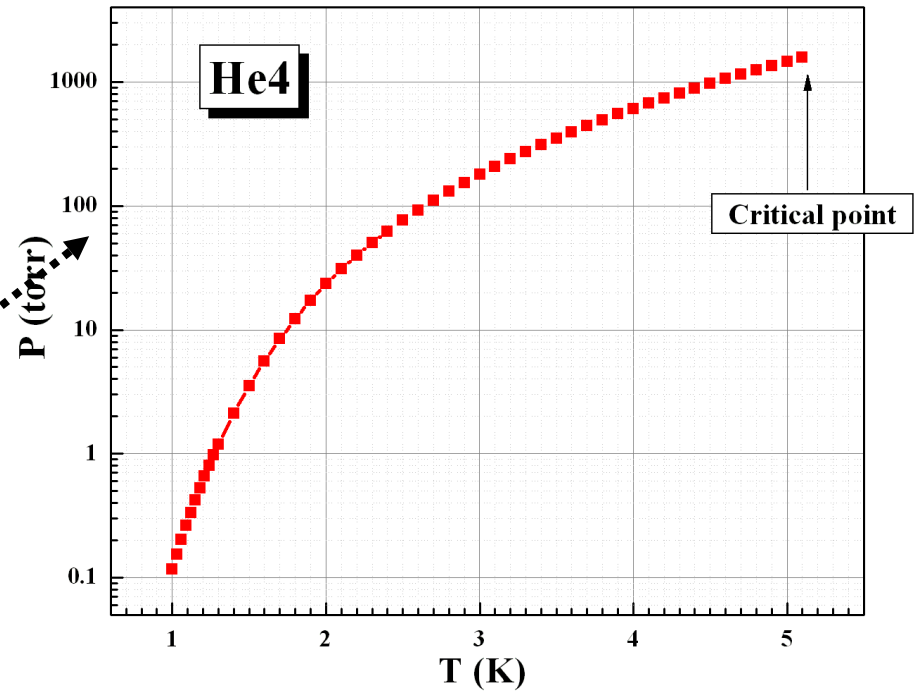
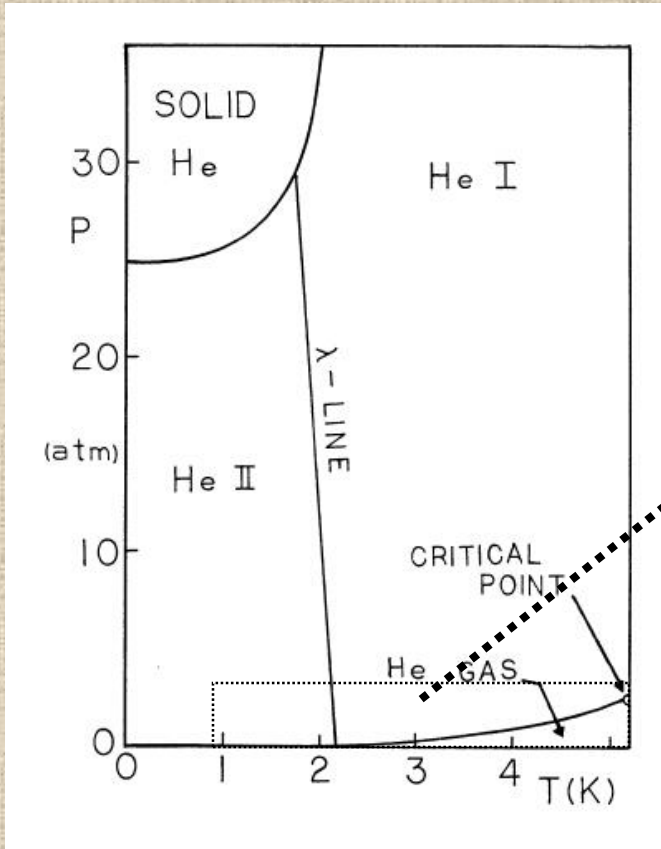

Critical point of He4 T=5.19K ,P= 0.227 MPa

Vapor Pressure Thermometry

Nitrogen P-T phase diagram

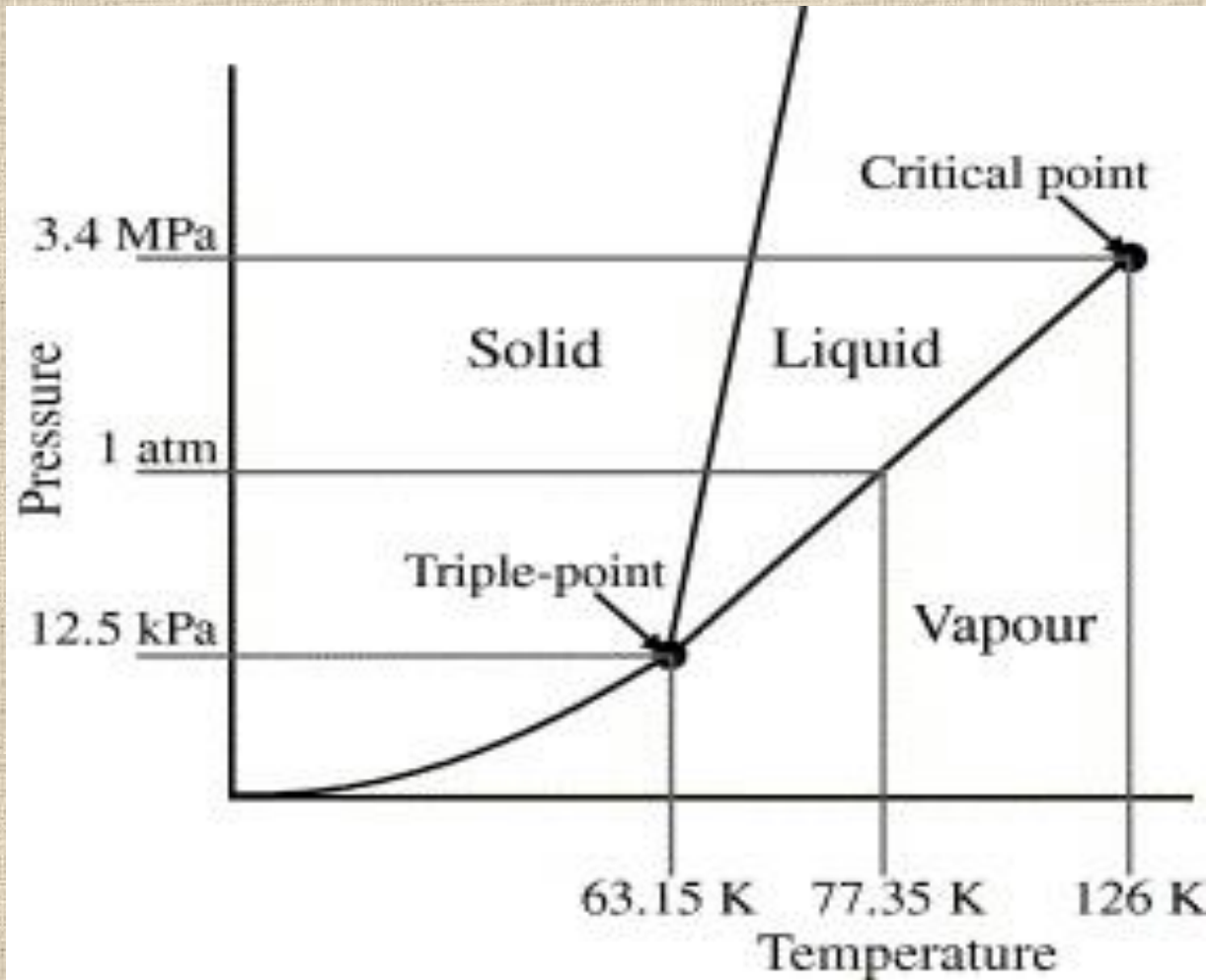

Some more exotic techniques of measuring the temperature

Johnson–Nyquist noise Thermometry

$$S^R = 4kTR(T)$$

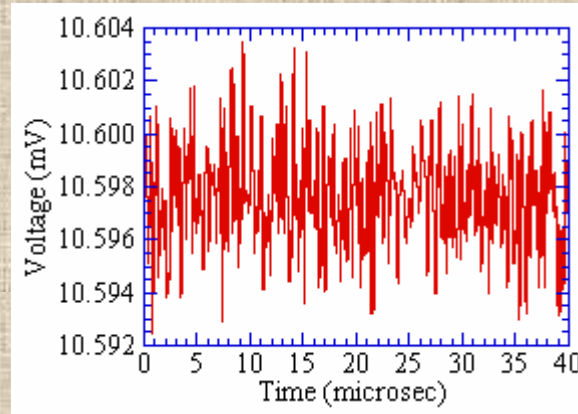

John Bertrand Johnson
(1887–1970)



Harry Nyquist
(1889–1976)

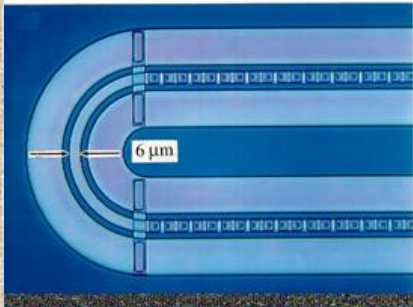

2004 IEEE Aerospace Conference Proceedings

Johnson Noise Thermometry for Harsh Environments

R. Kisner¹, C. L. Britton^{1,2}, U. Jagadish¹, J. B. Wilgen¹, M. Roberts², T. V. Blalock^{2,3}, D. Holcomb¹,
M. Bobrek^{1,2}, M. N. Ericson^{1,2}

¹Oak Ridge National Laboratory, MS6006, Oak Ridge, TN 37831-6006, BRITTONCL@ornl.gov

²Dept. of Electrical and Computer Engineering, The University of Tennessee, Knoxville TN

³Deceased

Courtesy by NIST

10/25/2017

Physics 403

16

Some more exotic techniques of measuring the temperature

Real time frequency domain fibreoptic temperature sensor using ruby crystals

J. R. Alcalá, S-C. Liao and J. Zheng

Department of Biomedical Engineering, Case Western Reserve University, Cleveland, OH 44106, USA

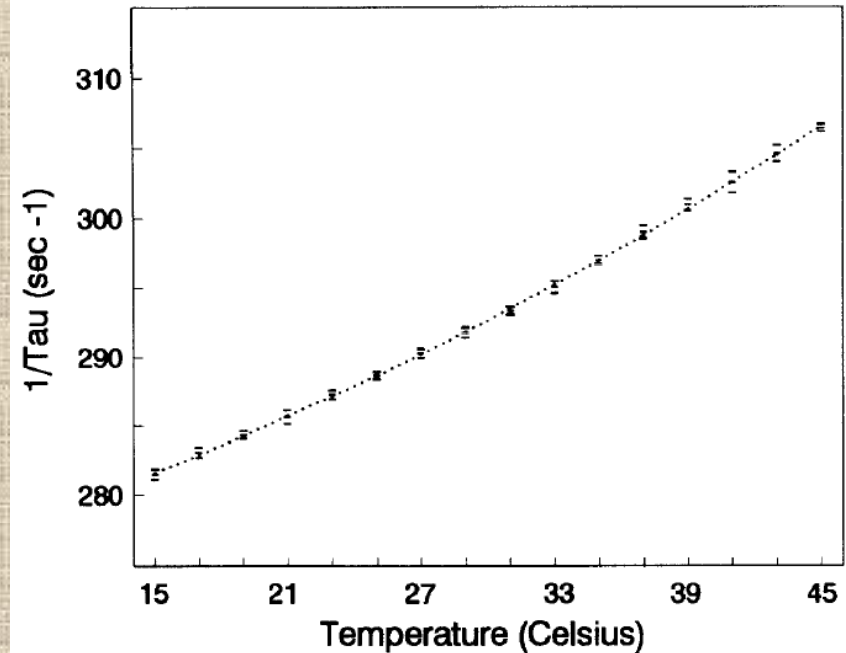

The use of optical methods, to invasively measure temperature, offers the advantage of electrical isolation, when compared to the traditional use of electronic thermometers. In some instances, optical techniques are necessary as in the case of clinical radio-frequency heat treatment, where interference from electromagnetic fields makes electronic thermometers unreliable. Optical tem-

Some more exotic techniques of measuring the temperature

Britton Jeter and Kyle Sendgikoski, P403, Spring 2014

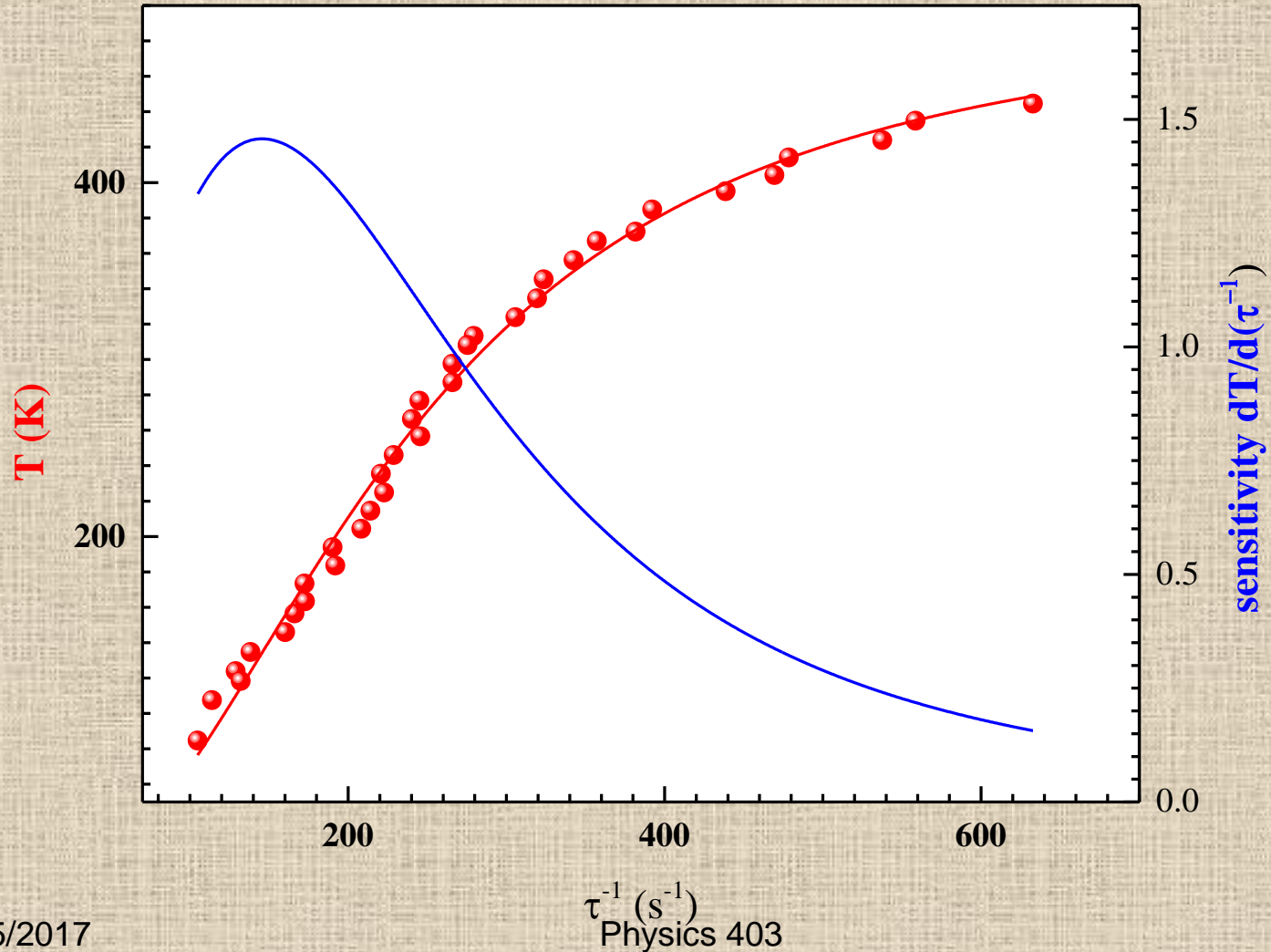

Sensors Calibration

Official list of a fixed temperature points recommended for sensor calibration (ITS-90)

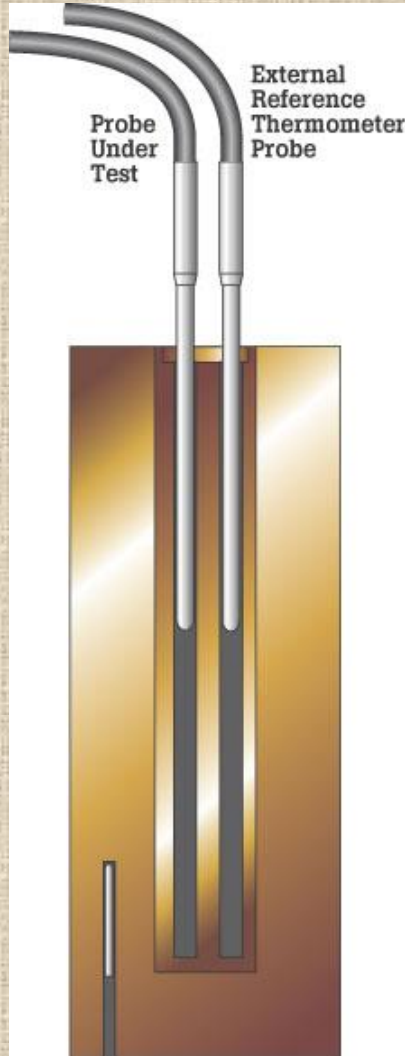

Temperature T_{90}/K	Temperature $t_{90}/^{\circ}C$	Substance	State
from 3 to 5	from - 270,15 to - 268,15	He - Helium	Saturated vapor pressure
83,805 8	- 189,344 2	Ar - Argon	Triple point
234,315 6	- 38,834 4	Hg - Mercury	Triple point
273,16	0,01	H ₂ O - Water	Triple point
302,914 6	29,764 6	Ga - Gallium	Melting point
429,748 5	156,598 5	In - Indium	Solidification point
505,078	231,928	Sn - Tin	Solidification point
692,677	419,527	Zn - Zinc	Solidification point
933,473	660,323	Al - Aluminium	Solidification point
1 234,93	961,78	Ag - Silver	Solidification point
1 337,33	1 064,18	Au - Gold	Solidification point
1 357,77	1 084,62	Cu - Copper	Solidification point

Comparison of temperature scales

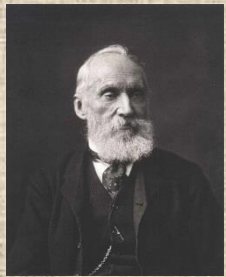

Kelvin



Celsius

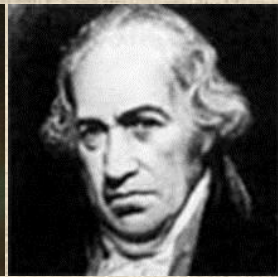

Fahrenheit

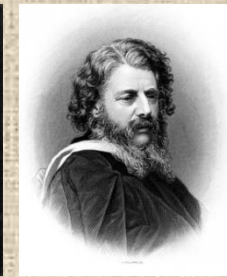

Rankine



Delisle

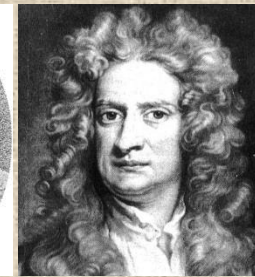

Newton



Réaumur



Rømer

Comment	Kelvin K	Celsius °C	Fahrenheit °F	Rankine °Ra (°R)	Delisle °D	Newton °N	Réaumur °R, (°Ré, °Re)	Rømer °Rø (°R)
Absolute zero	0	-273.15	-459.67	0	559.725	-90.14	-218.52	-135.90
Lowest recorded natural temperature on Earth	184	-89	-128	331	284	-29	-71	-39
Water freezes (at standard pressure)	273.15	0	32	491.67	150	0	0	7.5
Average human body temperature ²	310.0 ± 0.7	36.8 ± 0.7	98.2 ± 1.3	557.9 ± 1.3	94.8 ± 1.1	12.1 ± 0.2	29.4 ± 0.6	26.8 ± 0.4
Highest recorded surface temperature on Earth	331	58	136	596	63	19	46	38
Water boils (at standard pressure)	373.13	99.98	211.97	671.64	0	33	80	60
Titanium melts	1941	1668	3034	3494	-2352	550	1334	883
The surface of the Sun	5800	5526	9980	10440	-8140	1823	4421	2909

Temperature scales: reference temperature points

Temperature scale	Temperature point #1	Temperature point #2	K to °X conversion
Rømer scale	0°Rø – temperature of freezing of brine	60°Rø – temperature of boiling water	$[^{\circ}\text{Rø}] = ([\text{K}] - 273.15) \times \frac{21}{4} + 7.5$
Réaumur scale	0°R – temperature of freezing water	80°R – temperature of boiling water	$[^{\circ}\text{Ré}] = ([\text{K}] - 273.15) \times \frac{4}{5}$
Delisle scale	0°D - temperature of boiling water	150°D - temperature of freezing water	$[^{\circ}\text{De}] = (373.15 - [\text{K}]) \times \frac{3}{2}$
Rankine scale	0°Ra – absolute zero	491.67°Ra temperature of water freezing. (1°Ra=1 °F)	$[^{\circ}\text{R}] = [\text{K}] \times \frac{9}{5}$
Fahrenheit scale	32 °F temperature of freezing water	212 °F temperature of boiling water	$[^{\circ}\text{F}] = [\text{K}] \times \frac{9}{5} - 459.67$
Newton scale	0°N – temperature of freezing water	33°N – temperature of boiling water	$[^{\circ}\text{N}] = ([\text{K}] - 273.15) \times \frac{33}{100}$
Celsius scale	0°C temperature of freezing water	100°C temperature of boiling water	$[^{\circ}\text{C}] = ([^{\circ}\text{R}] - 491.67) \times \frac{5}{9}$